

Matrix² Delta Owner's Manual



The Ultimate Hybrid Studio Centrepiece

Matrix² Delta. This is SSL.

Solid State Logic
SOUND | | VISION

Solid State Logic

S O U N D | | V I S I O N

Begbroke, Oxford, England, OX5 1RU • +44 (0)1865 842300

320 West 46th Street, 2nd Floor, New York, NY 10036, USA • +1 (1) 212 315 1111

3700 Wilshire Blvd, Suite 720, Los Angeles, CA 90010, USA • +1 (1) 213 249 9229

3-55-14 Sendagaya, Shibuya-Ku, Tokyo 151-0051, Japan • +81 (0)3 5474 1144

7 bis, rue de la Victoire, le Blanc Mesnil, Paris 93150, France • +33 (0)1 48 67 84 85

Visit SSL at URL: www.solidstatelogic.com

© Solid State Logic

All Rights reserved under International and Pan-American Copyright Conventions

AWS 924, AWS 948, Matrix, *Matrix*², **Solid State Logic** and **SSL** are trademarks of Solid State Logic

All other product names and trademarks are the property of their respective owners

No part of this publication may be reproduced in any form or by any means, whether mechanical or electronic, without the written permission of Solid State Logic, Oxford, England

Document History

82S6MT065A	December 2013	Initial Release 1.0.2
82S6MT065B	April 2017	Delta Control 3.0.3

As research and development is a continual process, Solid State Logic reserves the right to change the features and specifications described herein without notice or obligation

E&OE

Matrix. Control your Creativity.

Welcome to Matrix. With the goal to bring the soul of analogue sound into the machinery of digital workflow, we designed Matrix - a seamless way to work in both worlds simultaneously. With unparalleled creative control over your DAW and analogue outboard, Matrix reconfigures your project studio around its most important element - you.

Matrix is a SuperAnalogue 16 channel, 40 line input mixing console with inbuilt signal router and multi-layer digital workstation control. It's simply the most elegant way to be creative with your entire arsenal of analogue outboard and cutting-edge digital equipment. Designed to be at the heart of your everyday creative process, Matrix is built to meticulous SSL hardware standards, to withstand even the most intensive studio use. Fully equipped to partner your monitors, workstations and outboard gear, Matrix lets you shape your project studio around the way you work.

The Matrix SuperAnalogue router manages the sends and returns of up to 16 outboard processor units, together with the assignment of the console's channel strip insert points. Using the Insert Matrix in the Matrix Remote software, any combination of your outboard gear can be rapidly inserted into any of your console channels, essentially giving you the ability to run your outboard as 'analogue plug-ins' within your DAW. Furthermore, the Insert Matrix can be controlled directly from buttons on the Matrix itself, allowing the insertion and removal of devices as well as rapid A/B-ing of analogue devices on a particular insert point.

With HUI and MCU modes, the 17 motorised faders and channel controls provide complete hands-on control over your DAW mixer, allowing you to enjoy mixing on a tactile, fully-featured control surface. Additionally, Matrix gives you access to transport and navigation functions, plug-in and virtual instrument parameters, and essential DAW commands, allowing you to work quickly and easily using just the console surface.

Alongside its integration of your analogue and digital equipment, Matrix is also a first-class SSL mixer, drawing on our 30 years of innovative analogue console design. The essential functions of recording and mixing - routing, level measurement and monitoring - are organised and arranged to make everything available at your fingertips to streamline the entire recording and mixing process. Matrix analogue architecture provides 16 channels, featuring dual line inputs, balanced insert sends and returns and a dedicated direct output. Channel level control utilises the same high resolution Digital Controlled Attenuator as fitted to the AWS 924, AWS 948 and Duality large format consoles. In Matrix the channel DCAs can be remote controlled via MIDI, enabling DAW tracks to provide full automation control of analogue levels. Dual stereo mix busses and four stereo returns with full stereo mix bus routing bring the total available mix inputs to 40. Powerful monitoring is a central feature of Matrix with independent Main and Mini monitor outputs, Artist Monitor output with independent EQ and source selection, and three external monitor inputs with source summing.

In short, Matrix is the new standard in project studio integration.

Contents

Contents	ii
About This Manual	vi
What Else You Will need	vi
Chapter 1 - Installation and Setup	1
Matrix Rear Panel Connections	2
Plugging Up Your Matrix	3
Audio Connections	3
Data Connections	4
Configuration of Data Connections	4
Matrix Network Connection Examples	5
Software Installation and Configuration	9
System Requirements	9
Software Installation (Mac)	9
Software Installation (PC)	10
iLok License Activation	10
Matrix Remote Configuration	11
DAW Layer Configuration	12
ipMIDI Configuration	14
Chapter 2 - Getting Started	16
Important Concepts	16
The Master Channel	16
Focus Modes	16
Preparing for the tutorial	17
STEP 1: Bringing Signal into the Channel	18
STEP 2: Routing to the Main Busses	19
STEP 3: Hearing your Signal	20
STEP 4: Sending to the Auxiliary Sends	21
STEP 5: Global Control of your DAW	22
STEP 6: Channel Control of your DAW	23
STEP 7: Sending Signal from the Channel Direct Output	24
STEP 8: Setting up Artist and Control Room Headphones	25
STEP 9: Listening Back to the DAW	26
STEP 10: Selecting a Title	27
STEP 11: Inserting Signal Processing into the Channel	28

Chapter 3 - Analogue Signal Flow	30
Introduction to Focus Modes	30
Operating Principles	30
The Master Channel Strip	31
The Digital Scribble Strip	32
Total Recall LEDs	32
The Channel Strip	33
Channel Inputs	33
Channel Outputs	33
Auxiliary Sends	35
The Centre Section	37
Master Bus Controls	37
Monitoring	39
Talkback	40
Metering	41
Devices and Chains - Front Panel Control	42
Devices	42
Building Chains On The Fly	42
Inserting Preset Chains	43
Removing Assigned Devices	43
SSL Soft Keys	44
MonOpt Soft Keys	45
Mon Soft Keys	46
Meters Soft Keys	46
Auto Soft Keys	47
TR Soft Keys	47
IP Soft Keys	48
Misc Soft Keys	48
Links Soft Keys	49
Matrix Automation	50
The δ Control Method	50
The MIDI Fader Method	59
The A-FADA Method	61
Extra Setup Information for using A-FADA with Logic	62

Chapter 4 - The Matrix Remote	63
Introduction to the Matrix Remote	63
The Projects Tab	64
Navigating the Projects List	65
Managing Projects	66
Managing Titles	67
Project and Title Notes	69
Track Sheets	69
The Total Recall Tab	70
Taking a TR Snapshot	70
Naming a TR Snapshot	70
Deleting a TR Snapshot	70
Recalling a TR Snapshot	71
The Channels Tab	75
Save And Load channel Names As A Preset	76
Renaming And Deleting Saved Channel Name Presets	76
The Insert Matrix Tab	77
Naming Devices	77
Setting Devices as Stereo	78
Inserting Analogue Devices Using The Insert Matrix	79
The DELTA Tab	82
Chapter 5 - DAW Control	83
Introduction	83
Layers	83
Matrix Console Layer Selection	83
Focus Modes	84
DAW Track Control	85
The Digital Scribble Strip	85
V-Pot Modes	86
SEL Key Modes	87
Transport Controls	89
Session Counter	89
Utility Buttons	90
Navigation Controls	90
Standard Profile Soft Key Assignments	91
Soft Key Overview	91
Pro Tools Standard Profile	91
Logic Standard Profile	97
Nuendo Standard Profile	100
CC (Continuous Controller) Standard Profile	104

Chapter 6 - DAW and CC Configuration	105
Matrix Console Layer Selection	105
Matrix Remote Layer Selection	105
Assigning DAW Layers	106
Selecting Profiles	106
Creating Profiles	107
Deleting Profiles	107
Renaming Profiles	107
Backing Up a Profile	108
Restoring a Profile	108
Disable Handshake	108
Selecting the Transport Master	108
Soft Keys	109
DAW Control Protocols, USB Commands and Menus	109
Soft Key Sets	109
Programming Soft Keys	110
Assigning DAW Protocol Functions	111
Assigning QWERTY Keystrokes	112
Creating Soft Key Menus	113
Renaming Soft Key Assignments	114
Assigning Modified Functions to Soft Keys	114
Removing and Replacing Soft Key Assignments	114
Editing Transport and Utility Button Assignments	114
Configuring CC Layers	117
CC Snapshots	118
The Digital Scribble Strip	118
Appendices	121
Appendix A - DAW Protocol Lists	121
Appendix B - Technical Specifications	125
Appendix C - Audio Connectors and Pinouts	129
Appendix D - Environmental Specification	131
Appendix E - Software Updates	133
Appendix F - Matrix Support	135
Appendix G - Maintenance	139

About This Manual

Whether you are an experienced studio engineer or an artist who is relatively new to the recording process, this manual will take you through the full breadth of Matrix functions. Chapter 1 guides you through the process of connecting up and integrating Matrix into your studio. Chapter 2 is a tutorial which provides an overview of the essential operating principles of Matrix, introducing both its analogue and DAW control capabilities, a proportion of which will be familiar to users with studio experience. Chapter 3 then examines the analogue mixing capabilities of the console in more detail. Chapter 4 focuses on the Matrix Remote software which controls a number of aspects of Matrix, including its relationship with outboard equipment. Chapter 5 introduces the operational use of Matrix for DAW control, working alongside the control surface documentation in your DAW's manual. The Remote is also used to configure and customise Matrix's control of DAWs, and this is the focus of Chapter 6.

A few simple conventions have been followed in this manual: Labelling on the console control surface or in software is in **bold**, retaining the capitalisation of the label itself. Back panel labelling is represented in plain type, also following the capitalisation of the labels.

Notes are used for clarification and occasionally for advanced descriptions. They are inset and italicized, and have a blue line below and above.

If you click on any page and chapter references within the manual, your .pdf viewer will jump to that location. Internet references are also hyperlinked in this way.

Note that these hyperlinks may not work in all .pdf viewers. They do work in Acrobat Reader, which is available from www.adobe.com.

What Else You Will Need

In order to make full use of your Matrix, you will require the following, in addition to the Matrix box contents:

- A computer on which to run the Matrix Remote software. This can be the same computer as you use for your DAW software.
- A Network Switch or Router. If you are running a setup with more than one computer, a network switch or router and additional network cabling will be needed (refer to the Network Connection Examples from Page 5 onwards).
- A USB KVM switch and/or hub. If you are planning to connect Matrix to more than one computer, you will need a USB switch. If you are only using one computer, the KVM switch will not be necessary. Depending on the complexity of your current studio setup, the hub may not be essential. You may well find, however, that you no longer have enough USB sockets on your computer. Note that the Matrix USB socket is Type B.
- Multicore cabling. To fully connect your Matrix, you will need up to seventeen 8-channel looms terminating in male 25-way D-Connectors.
- A Stand. There is a wide range of commercially available mixer stands which are suitable for Matrix. SSL are happy to recommend the Studiospares Z-Frame keyboard/mixer stand, and the Quik Lok ZM-2034 Mixer Stand. Alternatively, you can build Matrix into your desk surface using the dimensions listed in Appendix B.
- Digital cabling. Depending on your setup, you may need suitable cables to connect up the AES or S/PDIF digital I/O.
- Foot switches. You can also plug up to two momentary foot switches into Matrix.

Chapter 1 - Installation and Setup

This chapter covers everything involved in setting up Matrix. If you have not already done so, please refer to the separate printed Installation Guide for safety information and instructions on positioning and connecting the Matrix Power supply.

There are a number of ways in which Matrix can be set up to fit into your studio environment. The diagram below outlines the standard configuration:



Matrix Rear Panel Connections

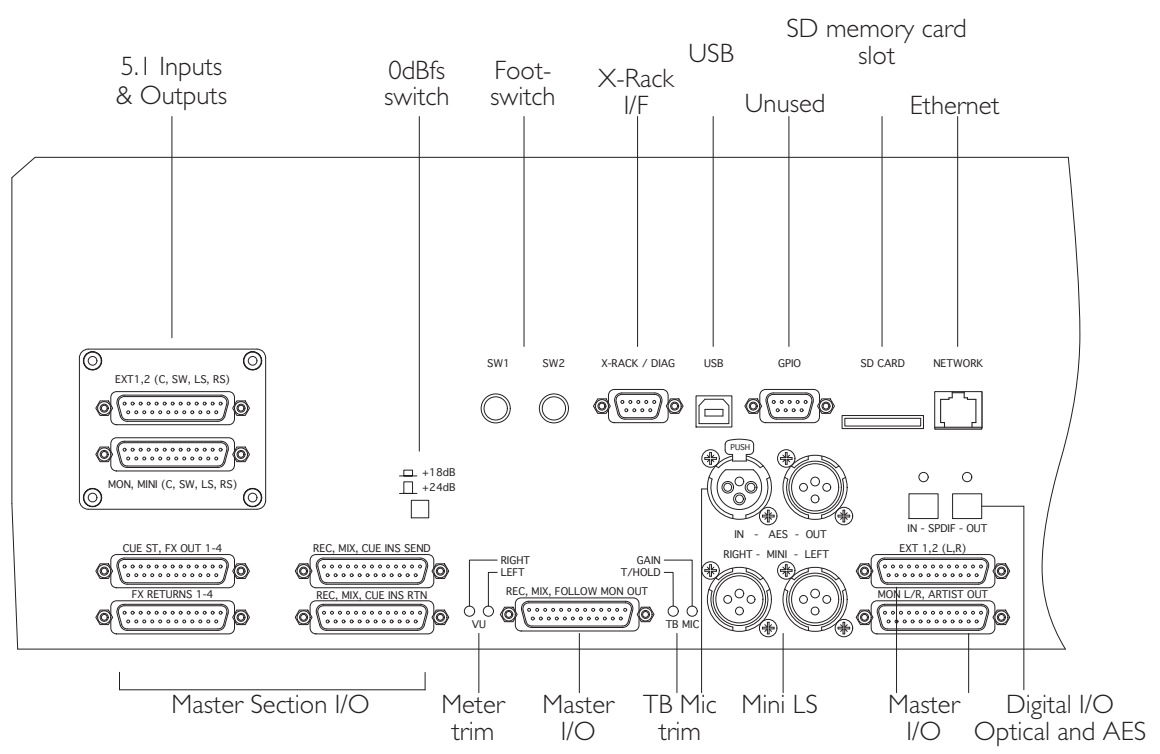
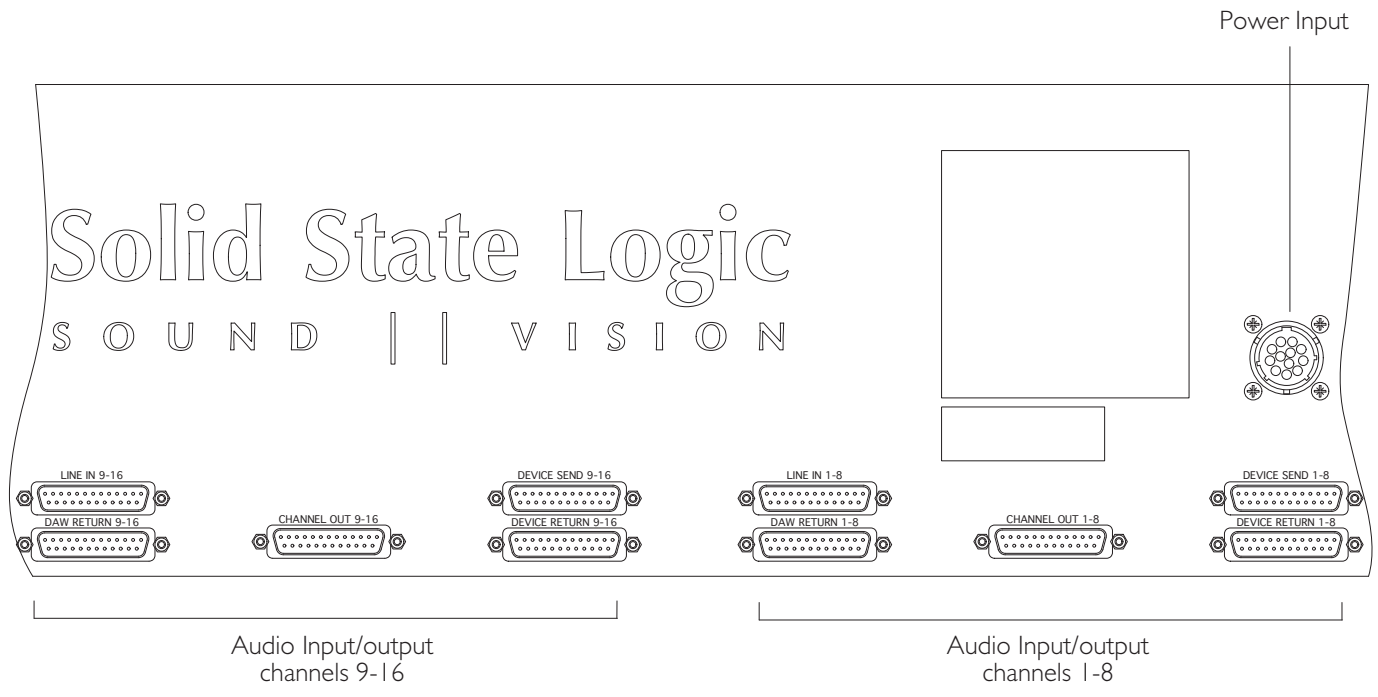

Plugging Up Your Matrix

Matrix2 includes the 5.1 Surround Monitor card assembly. This extends the EXT 1 and EXT 2 Inputs from 2 to 6 channels, thereby providing two 5.1 Inputs and additionally extends the MAIN and MINI Monitor Outputs from 2 to 6 channels (to provide 5.1 monitoring). Note that Left and Right EXT, MAIN and MINI signals appear on the rear DB25 connectors. See list below.

Audio Connections

All audio connections are made to the rear of the console using high quality 25-pin D-type female connectors - the only exceptions being the Mini LS monitor outputs which are available via 3-pin XLR male connectors. All connections are balanced, and all cable screens are connected to the Matrix chassis. 0VU meter level corresponds to +4dBu output level.

All D-connectors are wired according to the TASCAM DB25 specification. See Appendix C for connector pinouts.

Channel Connections

The connectors to access Matrix's channels are arranged in two groups each of five connectors. The first group provides access to channels 1-8 and the second group to channels 9-16.

Line Inputs	D25 female	Line level inputs to the channels - from mic amps, keyboards etc.
Device Send/Return	D25 female	Insert Matrix sends/returns returns to/from effects units
DAW Return	D25 female	Inputs from workstation (DAW - Digital Audio Workstation)
Channel Out	D25 female	Outputs to workstation

Master Section Connections

The Master Section connectors are allocated as follows:

Ext 1, 2 (L, R)	D25 female	External to Monitor inputs 1 and 2 (L, R)
Ext 1, 2 (C, LFE, LS, RS)	D25 female	External to Monitor inputs 1 and 2 (5.1 channels)
Mon L/R, Artist Out	D25 female	Main LS, Mini LS* and Foldback† sends (L, R)
Mon Mini (C, LFE, LS, RS)	D25 female	Main LS, Mini LS (5.1 channels)
Rec, Mix, Follow Mon Out	D25 female	Record, Mix and Follow Monitor main outputs (L, R)
Rec, Mix, Cue Ins Send	D25 female	Record, Mix and Cue insert sends (L, R)
Rec, Mix, Cue Ins Rtn	D25 female	Record, Mix and Cue insert returns (L, R)
Cue St, FX Out 1-4	D25 female	Cue Stereo and Effects sends 1-4 outputs
FX Returns 1-4	D25 female	Stereo Effects returns 1-4
Mini	XLR 3-pin male	Mini LS* outputs L and R

* Mini LS outputs are duplicated on the D25 and XLR connectors. Speaker outputs are at line level, requiring external amplification.

† Artist Out (Foldback Sends) should be used for Artist headphone feeds, not the Cue Sends.

Digital I/O

Digital signals are available as either AES3 balanced on digital XLR connectors or as S/PDIF signals on standard optical connectors.

The digital XLR connections should be wired using 110Ω cable.

AES In	XLR 3-pin female	AES/EBU monitor input
AES Out	XLR 3-pin male	AES/EBU bus output
S/PDIF In	TOSLink	Optical digital monitor input
S/PDIF Out	TOSLink	Optical digital bus output

Both digital outputs are always active. When an incoming digital signal is detected, the output will replicate its sample rate up to a maximum of 192kHz. With no input the output sample rate will default to 48kHz. See Page 38 for more details.

See Page 48 for a description of digital input source selection via the OptDAC soft key.

iJack and Headphones

The iJack and headphone sockets are located to the right of the transport control panel.

iJack:	Stereo 3.5mm jack	Allows the connection of an external line level signal source (such as an iPod or MP3 player) to be switched directly to the Matrix's monitors.
Headphones:	Stereo 1/4" jack	Headphone connection

Data Connections

Both Network and USB connections must be made between Matrix and the computer.

Network

- A standard RJ45 connector for Matrix-Workstation network data. A 3m crossover cable is provided which should be used to make a direct connection to the 'Network' port on the workstation computer - see the various setup examples on Pages 5 through 7 for an illustration of this and other connection methods.

USB

- Use the 3m USB-A to USB-B cable provided to connect the Matrix to a free USB port on your workstation computer. This connection carries USB keyboard commands generated from the console soft keys and is used to control the DAW via its supported keyboard shortcuts, supplementing the existing MIDI DAW control offered on Matrix.

Defining QWERTY Keyboard Nationality (Mac)

- Matrix emulates a UK keyboard. When Matrix is first connected to a Mac, a dialogue will be displayed which asks you to identify the new keyboard. In order to identify the keyboard type, the Mac then requires the key to right of the left **Shift** key to be pressed. In the SSL MISC soft key set (see Page 45), there is a key labelled KeybID. Pressing this key will send the required keystroke to the Mac to correctly identify Matrix as a UK keyboard.

Foot Switch Inputs

Sw1 & Sw2 Mono 1/4" jack Foot switch trigger inputs

X-Rack Interface

D9 female serial data port to facilitate connection to an SSL X-Rack for the transfer of Total Recall information. A suitable 2m cable is supplied with each X-Rack chassis.

Note: Also included on this connector is a second serial data port for diagnostic and service use.

Configuration of Data Connections

Network Wiring

To ensure the fastest possible communication between your workstation computer and Matrix, and to simplify the wiring between Matrix and computer, Matrix communicates with your workstation over Ethernet using the ipMIDI driver to emulate a multiport MIDI interface. To ensure minimum latency ipMIDI uses multicast UDP rather than TCP/IP. This means that:

- The network connection should be as short as possible and should only use routers that can support high data transfer rates. Problems have been experienced with some domestic routers, particularly when used with Pro Tools. Typical symptoms of a slow network connection are:
 - The Matrix fails to synchronise all controls when first connecting with the DAW.
 - Channel controls and scribble strips on channels 9-16 fail to update reliably when using the **Channel** keys.
- Because ipMIDI uses multicast UDP packets, messages between one computer and Matrix will be received by all other computers on the network, potentially causing problems in installations with more than one Matrix. The UDP packets can be blocked by using a firewall router and connecting the main network to the WAN connector. The firewall can then be configured to allow all traffic apart from UDP ports 21928 through 21947 which are used by ipMIDI and port 50081

which is used by the Matrix Remote application. Note that it may be necessary to use a separate Ethernet switch in place of an integrated firewall router switch, as some of these can not support the high data transfer rate required. The NetGear FS108 (an eight port switch) has been used successfully at SSL Begbroke.

Most systems can be easily configured with a direct connection between Matrix and the controlling computer.

Assigning the Matrix IP Address

By default, Matrix uses a fixed IP address of 192.168.1.2 which works well if Matrix is connected directly to your DAW. Alternatively, Matrix can be set to use a dynamically assigned (DHCP) address if your installation precludes a simple direct connection. Switching between the two methods is achieved via the IP SSL soft keys (see Page 45). If Matrix is connected to the computer via a network switch or router (with a DHCP server enabled), it should be set for DHCP, otherwise the Fixed option should be used. Note that the currently assigned address will be shown in the scribble strip.

- Once you have altered the IP mode, you need to turn Matrix off and on for the changes to take effect.
- An alternative fixed IP addresses can be set using the console diagnostic port. A custom serial cable (not supplied) will be required to achieve this - please refer either to the Matrix support pages on the SSL Website or SSL Technical Support for guidance on this.

Matrix Network Connection Examples

1 Direct Connection (no Internet Required)

This is the simplest way to setup Matrix with your computer.

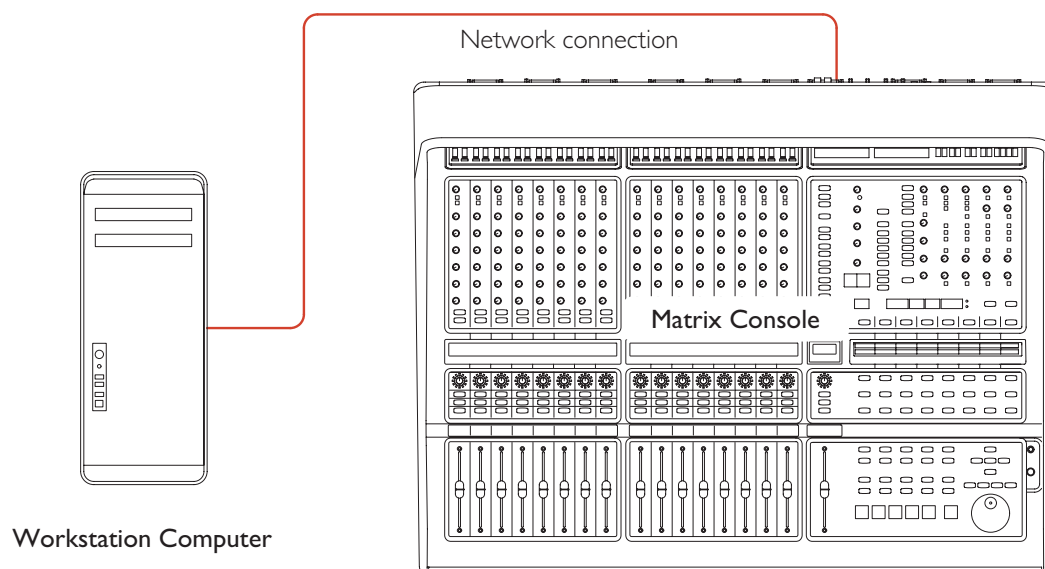

- Ensure that Matrix is set to use a fixed IP address: Use the SSL soft key on the console, go to the IP menu and check that Fixed is selected (see Page 45).
- Please note that many Macs with multiple Ethernet ports can only use one of those ports at any one time!
- Note also that if your workstation computer is a Mac, you should ensure that your Mac Airport is switched off. We strongly recommend this as Airport is known to cause conflicts with ipMIDI data. If you wish to use the internet, we suggest you configure Matrix with a Router/Switch (see example 2).



Network Connection Configuration (Mac)

- On the Mac, go to **System Preferences** and click on the **Network** icon.
- Fill in the **IP Address** and **Subnet Mask** boxes with the numbers shown opposite.



Network Connection Configuration (Windows)

- Go to **Network** and go into **Local Area Connection Properties**.
- Open up the option **Internet Protocol Version 4 (TCP/IPv4)**.
- Select **Use the following IP address** and then fill in the **IP Address** and **Subnet mask** boxes as shown opposite.

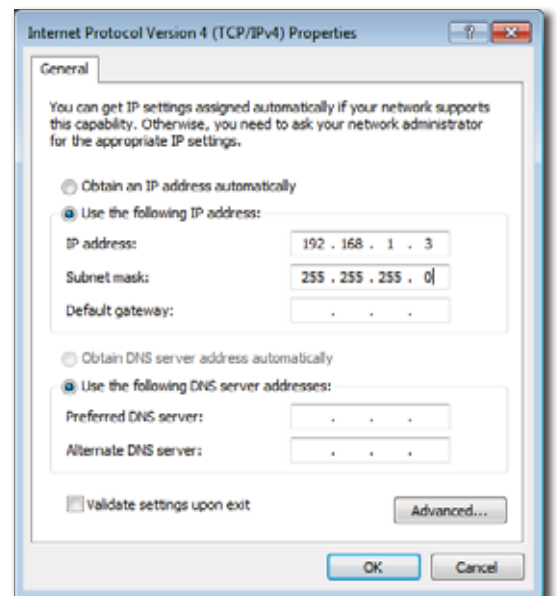

2 Router (and Switch) Connection using DHCP (allows access to Internet)

This connection method allows you to connect multiple devices to your home network and access the Internet at the same time.

The basic principle behind this method is that your Internet router acts as a DHCP server, dynamically assigning IP addresses to all the devices on your network. The simplest configuration would be as follows:

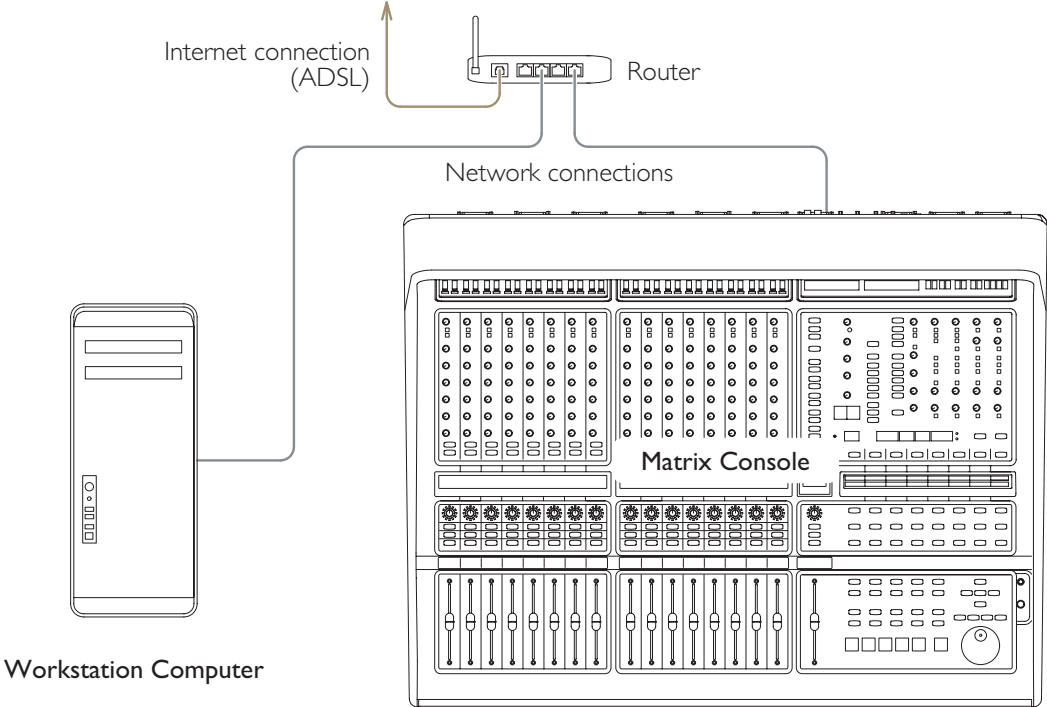

If you have more devices that you need to connect on your network, adding an Ethernet switch will allow more things to be connected:

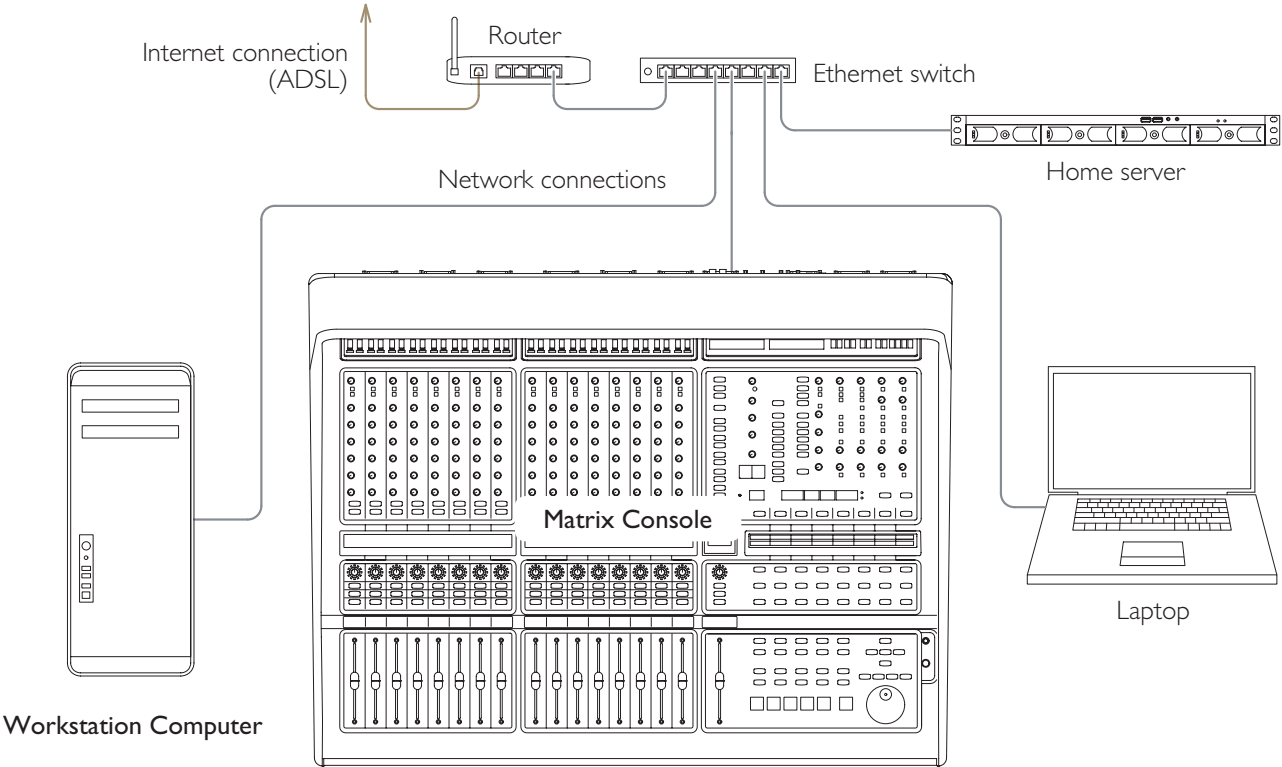

Network Connection Configuration (Mac)

- On the Mac, go to **System Preferences** and click on the **Network** icon.
- Set **Configure IPv4** to **Using DHCP** as shown here:
- Ensure that Matrix is set to use DHCP: Use the SSL soft key on the console, go to the IP menu and make sure that DHCP is selected (see Page 45).



Network Connection Configuration (Windows)

- Go to **Network** and go into **Local Area Connection Properties**.
- Open up the option **Internet Protocol Version 4 (TCP/IPv4)**.
- Choose the option **Obtain an IP address automatically** as illustrated here:
- Ensure that Matrix is set to use DHCP: Use the SSL soft key on the console, go to the IP menu and make sure that DHCP is selected (see Page 45).

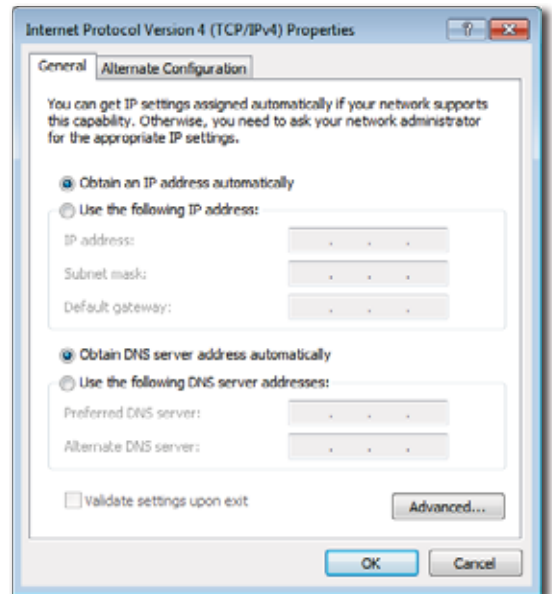

3 Connection in a facility that has multiple SSL consoles

If you are in a studio that has multiple SSL consoles, we recommend that you purchase one of our 'LAN integration network switches' from the SSL webstore. Due to the nature of UDP, if you have two SSL consoles on the same network with a normal router/switch setup, then you may find that the console in one room will start to control another. Our managed switch blocks UDP data on two of the ports, solving the problem and allows uplinking in a multi-room facility. Please visit the following link for more details and a picture example: store.solidstatelogic.com/catalog/36

Software Installation and Configuration

On the USB stick which came with Matrix you will find four programs to install. Install the program called **MatrixRemote** on the computer from which you intend to control Matrix, and install the programs **ipMIDI**, **SSL Delta Control** and **SSL Delta Control Matrix** on any computers which have a DAW installed which you intend to use with Matrix.

System Requirements

- Matrix Remote is a Java application and will run under Java Version 5 or higher. PC users can download the latest version from www.java.com
- ipMIDI is compatible with Mac OS X 10.7 upwards, and Windows 7, 8 and 10.
- SSL Delta Control plugins are compatible with Mac OS X 10.7 upwards, and Windows 7, 8 and 10.

Check the SSL website for the latest versions of the ipMIDI virtual MIDI interface driver and the Matrix Remote application. These can be found at www.solidstatelogic.com/support/consoles/matrix/downloads.asp

Software Installation (Mac)

Matrix Remote

- Mount the **MatrixRemote.dmg** disk image and open it. Drag the enclosed Matrix Remote application to the Applications folder, then to the Dock or any other convenient location.

ipMIDI

There are two versions of ipMIDI for Mac; V1.6 is suitable for OS X 10.6 (Snow Leopard) - 10.9 (Mavericks), whilst V1.7 runs on OS X 10.10 and upwards. Please choose the correct version for your Mac.

- Mount the **ipMIDI.dmg** disk image and open it. Double click on the **ipMIDI.pkg** file to run the installation program. Note that you will be asked to log out and in again once you have completed the installation. Once you have logged back in open **Audio MIDI Setup** and double click on the **ipMIDI** icon. Set the number of MIDI ports to 9 in the resulting pop-up.

Note that if you are upgrading an older copy of ipMIDI you must uninstall it before running the installer. To uninstall ipMIDI simply delete: '/Library/Audio/MIDI Drivers/ipMIDIDriver.plugin'. You should empty the Trash after deleting the '.plugin' file before running the installer.

SSL Delta Control Plugins

- Mount the **SSL Delta Control.dmg** disk image and open it. Follow the steps in the installer to install the Single-Fader Delta Control plugin. Follow the same process for the **SSL Delta Control Matrix.dmg** disk image to install the 16-Fader Delta Control plugin.

For more information on the differences between the two plugins, see page "Delta Plugins" on page 50

- The Delta Control plug-ins use the industry standard iLok 2 copy protection scheme. An iLok 2 USB key will need to be acquired to use Delta Control plugins. For more information about activating plugin licenses onto your iLok, see page 10.

For Matrix owners who purchased their console before May 2017 will need to purchase a Delta Control plug-in license from the SSL Web Store.

Software Installation (PC)

Matrix Remote

- Copy the **MatrixRemote.exe** file to the **Program Files** folder (or any other convenient location) then create a shortcut to it on your desktop and/or task bar. Double clicking on this will launch the Matrix Remote program.

ipMIDI

- Run the **setupipmidi_1.9.exe** application (note that the last part of the name may change depending on the version you are installing) by double clicking on it. Note that you will have to restart the computer at the end of the setup process. Once the computer has restarted right click on the **ipMIDI** icon in the task bar and set the number of MIDI ports to 9 in the resulting pop-up.

*Note that if you are upgrading an older copy of ipMIDI you must uninstall (using **Add/Remove programs**) it before running the installer.*

SSL Delta Control Plugins

- Run the **SSL Delta Control.exe** file. Follow the steps in the installer to install the Single-Fader Delta Control plugin. Follow the same process for the **SSL Delta Control Matrix.exe** file to install the 16-Fader Delta Control plugin.

For more information on the differences between the two plugins, see page "Delta Plugins" on page 50

- The Delta Control plug-ins use the industry standard iLok 2 copy protection scheme. An iLok 2 USB key will need to be acquired to use Delta Control plugins.

iLok License Activation

- Open the iLok License Manager software and login to your iLok user account. Insert your iLok USB 2 key into the computer. Click on 'Licenses> Redeem Activation Code'.

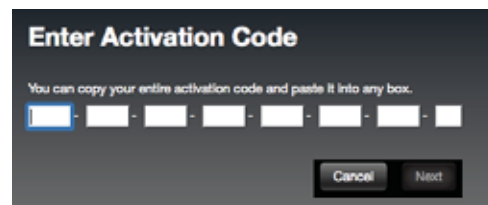
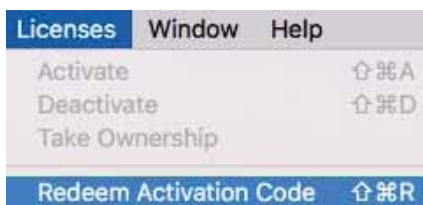

A printed activation code for the SSL Delta Control license is included with Matrix - enter this activation code in the 'Enter Activation Code' box.

Once an SSL Delta Control license has been deposited into your account, right-click (Windows) / Ctrl-click (Mac) on the license. Click Activate, and then select your iLok USB key.

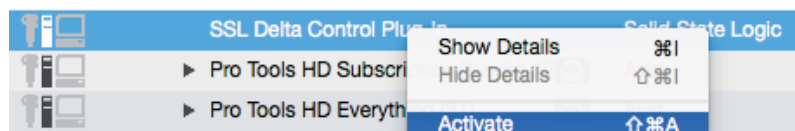

For Matrix owners who purchased their console before May 2017 will need to purchase a Delta Control plug-in license from the SSL Web Store.

Matrix Remote Configuration

- Having completed the set-up guidelines described above, run the Matrix Remote software.

In the bottom left-hand corner of the Remote window there is a Find () button, along with indication regarding the current status of the connection to Matrix:



When the Matrix Remote first opens, it searches for a Matrix console to control. If it finds one, it will automatically link to that console. This will be indicated by the **Status** to the right of the  button displaying a green **'Matrix Connected - Matrix SN XXXX'** message, where **SN XXXX** is the ID of the Matrix console found.

If the Remote cannot find any Matrix consoles, its status will display the message **'No Matrix Found, click on Find.'**

- If this happens, check your connections and press  to bring up the **Find Matrix** pop-up.
- If the Remote still cannot find any Matrix consoles, the list in the pop-up will be empty. In this case, recheck the connections and press the **Find Matrix** button in the top right of the pop-up, and the Remote will rescan for consoles.
- Once the Remote has found the console, it will appear in the pop-up. Highlight the Matrix ID and then click on **Select**.

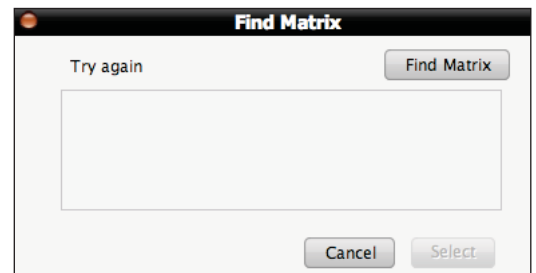

Once a connection has been made to Matrix, the green **'Matrix Connected - Matrix SN XXXX'** message will appear in the **Status** field:



DAW Layer Configuration

Matrix can connect to up to four DAWs and software MIDI devices, though only one program can be controlled from the Matrix control surface at one time. In order to cater for setups which include multiple programs, each can be assigned its own Matrix 'layer'. Control operations performed on the Matrix control surface will then affect whichever program is assigned to the currently selected layer.

Layers are programmed in the **DAW** tab in the Matrix Remote:



Matrix Remote Layer Selection

The layer being configured in Matrix Remote is selected via the **DAW** tab's **Layer** radio buttons, located in the middle of the tab towards the top. All other functions in this tab, with the exception of the **Transport Master** selection, are specific to the selected layer.



- First, decide which DAW or MIDI device will be assigned to which layer.

Note that you can always review your layer assignments; This need not be a permanent configuration.

- Next, assign an appropriate Profile to each of the layers to be used. A Profile defines which control protocol (HUI, MCU or CC - See Chapters 5 and 6 for more details) is used to control the DAW or MIDI device, and also includes up to five sets of soft keys for a specific DAW program. There are four pre-loaded default Profiles on Matrix:

- A HUI Profile configured for Pro Tools
- An MCU Profile configured for Logic
- An MCU Profile configured for Nuendo/Cubase
- A CC (MIDI Continuous Controller) Profile for MIDI devices.

Eventually you will personalise your Profiles. As part of the personalisation process, Profiles for other DAW packages can be created using the Pro Tools default Profile for HUI DAWs, and the Logic default Profiles for MCU DAWs (see Chapter 6). However, for now, the important thing is to make sure you assign each DAW layer the right protocol. If you are running a DAW other than those listed above, please refer to its manual to establish which control protocol it uses.

- Using the **Layer** buttons, located in the middle of the **DAW** tab towards the top, select the layer you are planning to assign to your first DAW.
- In the **Profile Setup** area found in the top left corner of the **DAW** tab, select the correct default Profile from the **Selected Profile** drop-down list.
- If the new Profile you select uses a different protocol than that which was previously selected, a pop-up will appear asking you to reboot Matrix. Press **OK**. If you have more layers to set up, you can select the Profiles on all of them before rebooting. Once you have selected all the Profiles required for now, switch the console off and on again.

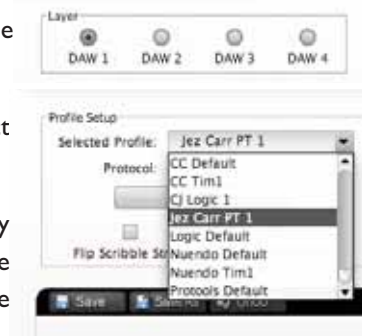

Note that once the protocol has been changed, the soft key assignments are locked out until the reboot is performed.

Please refer to Chapter 6 for more on DAW layers.

ipMIDI Configuration

The ipMIDI driver enables your DAW to send and receive MIDI control data via the network connection, and must be configured to match the requirements of Matrix before it can be used.

Mac

Once the driver has been installed and you have logged back in, use the **Finder** to navigate to the **Utilities** folder (in **Applications**). Double-click **Audio MIDI Setup**, select **MIDI Devices** and double-click on the **ipMIDI** icon. Set the number of MIDI ports to 9 in the resulting pop-up.

Windows

Once the computer has restarted after installing the driver, right-click on the **ipMIDI** icon in the **Task Bar**, select **ipMidi - MIDI over Ethernet** and set the number of MIDI ports to 9 in the resulting pop-up.

MIDI Port Mapping

MIDI control for the four Matrix Layers is split across thenine ipMIDI ports which means that your DAW must be configured to match the table here.

Note that CC ('Continuous Controller') Layers only use the first MIDI port in their layer. All CC data is sent on MIDI Channel 1.

Matrix DAW Layer	Matrix Channels	ipMIDI port
1	1 to 8	1
	9 to 16	2
2	1 to 8	3
	9 to 16	4
3	1 to 8	5
	9 to 16	6
4	1 to 8	7
	9 to 16	8
Automation	1 to 16	9

MIDI Port 9 is concerned with automation, not layer configuration. Use of this port is described fully on Page 46.

Setting which ipMIDI ports the DAW should use is performed using the MIDI controller configuration page of your DAW. Below and overleaf are two examples using Pro Tools and Logic Pro.

Pro Tools

- In the **Setup** menu, click on **Peripherals** and select the **MIDI Controllers** tab.
- For MIDI controllers 1 and 2, select '**HUI**' as the MIDI controller '**Type**' and assign the MIDI ports for this layer's DAW to the two MIDI controllers, as listed in the table above.

As an example, if Pro Tools has been assigned to Layer 1 (so using ipMIDI ports 1 & 2), the **MIDI Controllers** tab should look as opposite.



*Please note, if using Pro Tools on Windows, ensure you are running Pro Tools as an **Administrator**. Not doing this can result in one way HUI communication!*

Logic Pro

The DAW protocol used by Logic Pro is the Mackie Control Unit (MCU) protocol. Therefore when a Logic Profile is assigned to a Matrix DAW layer, in order for Matrix to control Logic, a Mackie Control together with a Mackie Control Extender must be added to Logic Pro. Click on **Preferences** then **Control Surfaces Setup** to access the menu shown below.

Both the Mackie Control and Mackie Control Extender provide just eight faders. Therefore Matrix faders 1-8 are mapped to the Mackie Control ports along with the master fader and DAW Control function switches whilst faders 9-16 are mapped to the Mackie Control Extender ports. The actual ipMIDI ports used will depend on which layer (or layers) have a Logic Profile assigned. (Refer to the previous page for a list of Matrix's MIDI port assignments.)



The screenshot opposite gives an example of Logic having been setup on DAW 1 layer. The Mackie Control has its Input and Output ports set to 1 and the Mackie Control Extender has its Input and Output ports set to 2.

It is recommended that you delete any Mackie controllers automatically created on set-up, and recreate them manually. Note that if the physical arrangement is reversed, then the Matrix faders will not map correctly to the on-screen faders in Logic.

If Logic is the only DAW connected to Matrix, then provided that there is only one DAW Layer set up with an MCU based Profile, Logic should automatically detect the two virtual controllers which will be shown in the Logic **Control Surfaces Setup** menu (as shown above), with the appropriate Matrix ipMIDI ports assigned. If Logic fails to detect the control surfaces, then the controllers can be added manually via the **New, Install** menu and the appropriate MIDI Out port and Input assigned. Full details can be found in the online Logic Pro Control Surfaces Support Guide in the Logic **Help** menu.

If Matrix is set up with multiple MCU profiles in the DAW layers, then the automatic detection option must be disabled and the controllers added and configured manually. Check the **Disable Handshake** box in the **DAW** tab in Matrix Remote (located below the **Edit Profiles** button) for all the DAW layers assigned to a MCU Profile *prior* to starting the Logic application. This will prevent Logic automatically detecting multiple Mackie Control Units.

For other DAWs, please refer to the relevant User Guide for details about configuring MIDI controllers.

*See Chapter 6 for a description of the Remote's **DAW** tab.*

Chapter 2 - Getting Started

The aim of this chapter is to familiarise you with the basics of operating your Matrix. We will restrict ourselves to simple operations and leave more complex elements to the following chapters. You may find it helpful to complete the whole tutorial before exploring the references to more detailed parts of the manual.

Important Concepts

Before we get going, there are a couple of important operating principles which need to be explained:

The Master Channel

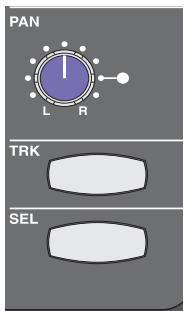

While many of the channel's controls are located in the physical channel strip, a number are instead found in the Master Channel (shown right) located in the top left-hand corner of the desk's centre section. The Master Channel gives you access to additional channel strip controls for whichever channel strip is assigned to it using the upper **SEL** button, located above the numeric display, in the middle of the channel (shown left).

*Note: There is a second **SEL** button in the channel, located a little lower on the channel strip, just above the fader. This button is associated with DAW control, not assigning the Master Channel. The DAW **SEL** button is examined on Page 87.*

Multiple channel strips can be assigned to the Master Channel. See Page 31 for details.

Focus Modes

Matrix combines two distinct modes of operation in one control surface, providing control of both the analogue signals and the DAW functions associated with the modern recording environment. In order to accomplish this within a compact space, the console can operate in two 'Focus' modes, focusing on either the analogue or DAW control functions. These modes are simply called Analogue Focus and DAW Focus.

Focus modes primarily affect the channel faders and their **CUT** and **SOLO** buttons which control the analogue signal when in Analogue Focus mode, but send control messages to the DAW when in DAW Focus mode. Focus modes also affect the channel meters which normally meter the analogue signal in Analogue Focus mode but replicate the DAW track metering in DAW Focus mode.

Matrix's mode is selected and indicated by the large Focus button, located directly underneath the Master Channel, on the left of the centre section (at the bottom of the graphic on the right). Pressing this button swaps between Focus modes. It is lit to indicate Analogue Focus, and unlit to indicate DAW Focus.

Note: It is important to distinguish between DAW Focus mode (where the desk's channels control the tracks within the DAW) and DAW input selection within Analogue Focus mode (where the desk's channels control the analogue signal returning from the DAW).

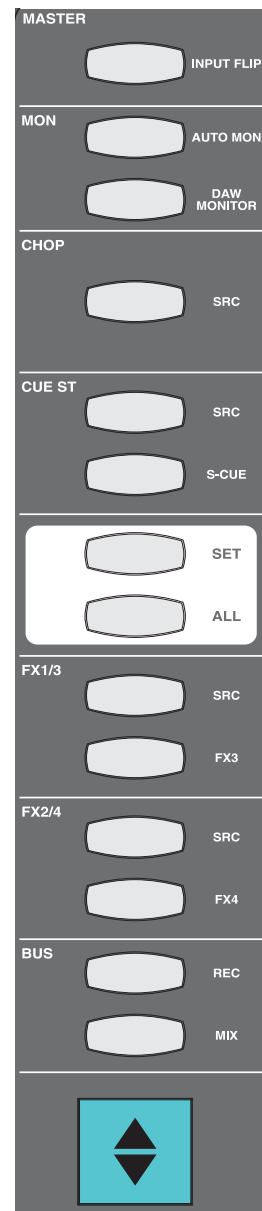

Preparing for the tutorial

This tutorial assumes that you have followed the instructions in Chapter 1 (Installation and Setup), and have therefore installed and configured the Matrix Remote and ipMIDI software, set up at least one DAW layer, and made at least the following connections:

- One channel input ('line in'), output ('channel out') and DAW return (the tutorial refers to Channel 16, but any will do).
- One insert ('device') send and return (the tutorial refers to Insert 1, but any will do).
- One FX send with stereo return (the tutorial refers to FX3, but any will do).
- Your main monitors and engineer's headphones.

You will also need to create a session in your DAW with at least one audio track with its input and output assigned to the channel you are using for this tutorial. Name this channel **Test**.

Each step of this tutorial also presumes that your Matrix is in the state it would be if all the previous steps had been accurately followed, and that no other buttons have been pressed in the process. If the desk doesn't respond in the way described, please review the previous steps as well as these preparatory instructions.

For the purposes of this tutorial, we suggest you find a fairly constant audio source, such as a CD player, for the channel input. The tutorial will presume that you are using channel 16, simply because it is close to the centre section. If your setup requires you to use a different channel, then that will work equally well. We also suggest that you create some obvious signal processing for both the insert (an EQ with extreme settings, for example), and the FX send (a huge reverb, for example). Once again, we will presume you have connected up DEVICE SEND and RETURN 1 and FX 3 (returning on Stereo Return 3), but if your setup requires you to use different connections, then that will work equally well.

STEP 1: Bringing Signal into the Channel

In this step, we will simply learn how to bring signal into the channel from the D-connectors on the Matrix back panel.

- First, ensure that the desk is in Analogue Focus mode, not DAW Focus mode, by checking that the Focus button (shown right) is lit.
- Press the upper **SEL** key on Channel 16. It will light to indicate that it is selected. The Master Channel is now assigned to channel 16.



*Note: There is a second **SEL** button in the channel, located a little lower on the channel strip, just above the fader. This button is associated with DAW control, not assigning the Master Channel. The DAW **SEL** button is examined on Page 87.*

- Find the **INPUT FLIP** button at the top of the Master Channel. This button determines which of the two channel inputs is feeding the channel: the main (line-in) input, or the DAW return. Make sure the button is lit green, indicating that the main input is selected. If it is red, indicating that the DAW return is selected, press it to select the main input.

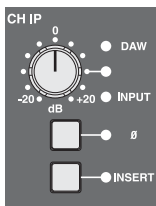

In the channel strip, the LEDs to the right of the grey gain pot labelled **CHIP** (at the top of the channel) also indicate the input selection: **INPUT** or **DAW**.

- Use the gain pot to adjust the gain of the input. Your CD signal should now be shown in the meter above the channel strip, and you can use this to adjust its level.
- Lift the channel fader to 0dB and check that neither the **SOLO** nor **CUT** buttons above the fader are lit. We will examine these controls in Step 7.

Note: You won't hear your signal until Step 3.

STEP 2: Routing to the Main Busses

Having brought signal into the channel, we will now learn how to bring it out again. We will cover more of the channel output options in Steps 4 and 7.

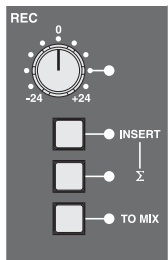

- Press the **REC** button in the **BUS** area towards the bottom of the Master Channel. This routes the signal to the record bus. The button will light red to indicate that this routing is active. Your CD signal should now be shown in the **REC** meter, to the right of the VU's above the centre section.



- Adjust the level of the record bus using the grey gain pot in the main **REC** bus controls, located in the top-right of the centre section (shown left).

There are two ways to route the signal to both record and mix busses:

Firstly we will route just this channel to both busses:

- Press the **MIX** button, below the **REC** button in the Master Channel. It will light yellow to indicate that this routing is active. Your CD signal should now be shown in the **MIX** meter, to the right of the VU's above the centre section.

Secondly, we will route the whole record bus to the mix bus:

- So as not to double the routing, deselect the mix bus routing from the channel by pressing **MIX** again.
- In the **REC** area of the centre section, press the **TO MIX** button. The LED next to it will light to indicate that this routing is active.

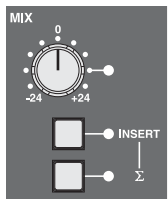

The mix bus level is adjusted in two places:

- Lift the master fader, to the right of the channel faders, to 0dB.
- Turn the gain pot in the main **MIX** bus controls, located to the left of the **REC** bus controls. In order to distinguish the mix bus from the record bus in the following step, leave the mix bus level about 20dB lower than the record bus level.

STEP 3: Hearing your Signal

In this step we will set some basic monitoring using the **MAIN MONITORING** area of the centre section, to the right of the Master Channel.

- Check that the large blue pot marked **MONITOR LEVEL** is not turned up too high and that you have switched on your main monitors!
- Press the **REC** button, to the right of the large pot. It will light red to indicate that you have selected the record bus for monitoring. Your CD signal should now be shown in the **MON** meter, to the right of the VU's above the centre section.
- Turn the monitor volume up using the **MONITOR LEVEL** pot until you can hear your CD.
- If you can't hear anything, check that the **DIM** and **CUT** buttons beneath the monitor volume are unlit, indicating that the mix is neither dimmed nor cut.
- If you still can't hear anything, press the **SOLO CLEAR** button in the top right of the monitoring area. This clears any solos that might have been activated.
- If there's still no sound, check your connections and go back to Step 1!

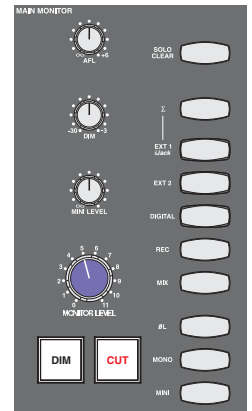

- Still in the **MAIN MONITORING** area, press the **MIX** button, located below the **REC** button in the monitoring section. The **REC** button's light will go out and the **MIX** button will light yellow to indicate that you have switched to monitoring the mix bus. Because you have set the mix bus level lower than the record bus, this action should cause the monitoring volume to drop. You may want to increase the mix bus gain now, so that you can hear the mix bus clearly for the rest of the tutorial.
- Press the **DIM** button below the main volume. This makes the monitoring immediately quieter, and the button lights to indicate that it is active.
- Adjust the middle of the three smaller grey pots, marked **DIM** to define how much difference this button makes.
- Press the **DIM** button again to cancel it.
- Now press the **CUT** button. This makes the monitoring immediately silent, and the button lights to indicate that it is active. Press the **CUT** button again to cancel it.

STEP 4: Sending to the Auxiliary Sends

Matrix has six auxiliary sends, the first two forming the Stereo Cue (**CUE ST**) send (which you will probably use for monitoring for musicians) and the remaining four labelled **FX 1-4** (which you will probably use for feeding global effects such as reverb units).

- Check that the gain pots for the overall bus levels, located in the top right corner of the centre section (**FX1** is shown right), are all set to 0dB, with the white line pointing towards the meters. This will allow you to see what happens in the meters when you turn the pots in the channel.

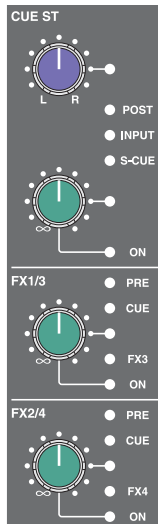
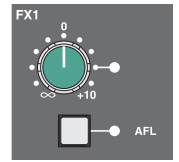

The first two pots beneath the **CHOP** are the pan and gain trim for the **CUE ST**, which we will cover in Step 8. The stereo cue functions similarly to the FX sends which we will concentrate on here: The two pots below the stereo cue are the gain trim for the FX busses. FX1 and 3 share a pot, as do FX 2 and 4.

- Press the upper gain pot, labelled **FX1/3**, to switch on FX1. The LED below it and to the right will light to indicate that it is on.
- Use the pot to adjust the FX gain, using the **FX1** meter to the right of the VU's as a reference.
- In the Master Channel, press the button marked **FX3**. This swaps the **FX1/3** gain pot from controlling the **FX1** send level to controlling the **FX3** send level. The **FX3** button will light to indicate that this swap has been made, as will the **FX3** LED to the right of the **FX1/3** pot. Notice that the **FX1** meter has gone blank and the **FX3** meter now reflects the CD player. The settings you created for the **FX1** send transfer automatically to the **FX3** send.

FX busses 2 and 4 work in exactly the same way as FX busses 1 and 3, using the next gain pot down.

Once you have sent signal to the aux busses, you need to set the overall output level of the bus. Each aux bus has its own control area, and you have already looked there to check that they are turned up sufficiently. For this tutorial, we will use **FX3**, as well as **ST RET 3** (Stereo Return 3, shown right).

- In the **FX3** area in the very corner of the centre section, turn the gain pot to adjust the output signal level.
- Press the **AFL** button in the **FX3** area to listen to the **FX3** bus send. Press it again to return to normal monitoring.
- In the **ST RET 3** area, located below FX sends 1 and 2, press **MIX** to send the returning signal to the mix bus. You should now hear the processing you created added to the clean CD signal in the monitoring.
- Press the **AFL** button below the **ST RET 3** gain trim to listen to the signal on its own.
- Adjust the level of the return using the gain trim, and the left-right balance using the pot above the gain trim.
- Press the **MONO** button above the balance control. This reduces the stereo return to mono. The balance pot will now be a pan pot. Press the **MONO** button again to restore the return to stereo again.
- Press the **AFL** button again to return to normal monitoring.

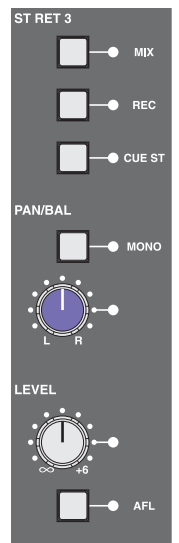

For more information on auxiliary sends, including altering the point in the channel which feeds them, see Page 36.

STEP 5: Global Control of your DAW

In this step in the tutorial we are going to concentrate on global control of the DAW, leaving in-channel controls to Step 6.

Note that the DAW control elements of Matrix function within the protocol of the DAW being controlled, as described in Chapter 1. Please refer to your DAW control surface documentation for more details.

- Find the **DAW LAYER SELECT** buttons, located in the centre section, below the digital scribble strip, and select the layer on which you have configured your DAW. The selected button lights to indicate that it is active. Layer 1 is active when none of the buttons are lit. If you wish to use Layer 1 and another layer is selected, press the lit button to return to Layer 1.

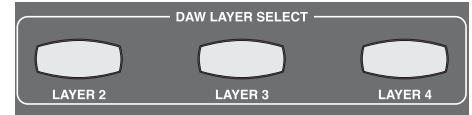

- Press the Focus button, located immediately below the Master Channel in the centre section. It should now be unlit, indicating that you are now in DAW Focus mode. The console is now focussed on controlling the signals inside the DAW rather than the analogue signals coming through the desk. You will notice that any channel names you have created in the DAW now appear in the digital scribble strip that runs through the middle of the desk, possibly in a shortened form.

Note that the DAW track names that appear in the Matrix channels refer to the tracks within the DAW that the Matrix channel is controlling, not an analogue signal being fed from the DAW return. The control of a DAW track may appear in a different Matrix channel from the analogue signal fed out from that DAW track, whose channel is fixed.

- Find the main Matrix transport controls, located at the bottom of the centre section. Above the main transport controls you will find two rows of five buttons. These give you access to some of the more complex DAW controls. If you operate any of the transport controls you will notice that they now control the transport of your DAW.

*Note: The **ARTIST** button is concerned with talkback, not transport control, so you can ignore it for now.*

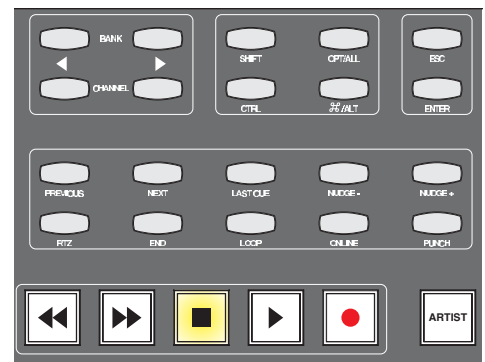

- Above and to the left of the transport controls, you will find the **BANK** and **CHANNEL** keys. These buttons scroll the DAW tracks through the Matrix channels. **BANK** scrolls the tracks 16 at a time, whereas **CHANNEL** scrolls them one at a time. These buttons allow the 16 Matrix channels to control more than 16 DAW tracks. Make sure that you leave the DAW track which is being fed from Channel Out 16 (which you named **Test**) in one of the channel strips (not necessarily channel 16).
- To the right of the transport controls is a large black wheel with nine buttons above it. Ensure that the cursor key **MODE** button (towards the top, surrounded by arrow keys) is unlit. If it is lit or flashing, press it until it is unlit. Also ensure that no Wheel Mode switches are lit. If one is, press the lit button to deselect it.
- Refer to your DAW control surface documentation to determine the default function of the Scroll Wheel and Cursor keys. Note that when controlling Pro Tools the Jog Wheel will scroll the timeline forwards and backwards - this is not a normal Pro Tools function.

In this tutorial we are only skimming the surface of the control capabilities of Matrix. See Chapters 5 and 6 for more details of more advanced DAW control functions.

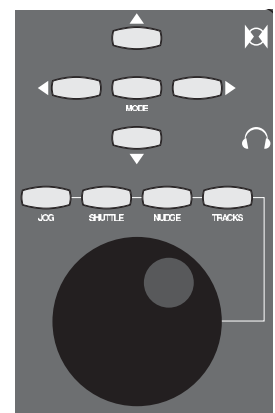

STEP 6: Channel Control of your DAW

In this step we will turn our attention to control of the DAW track.

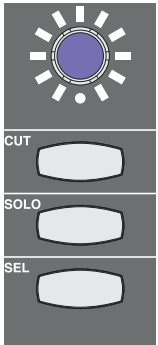

- Still on the Matrix console, press the **CUT** button in the channel controlling the **Test** track, located above the channel fader. You will notice that the **Test** track will cut in the DAW. On Matrix, the channel **CUT** button will light. Press the **CUT** button again to deactivate it.
- Press the **SOLO** button in the channel controlling the **Test** track, located below the **CUT** button. You will notice that the **Test** track will solo in the DAW. On Matrix, the channel **SOLO** button will light and the **CUT** buttons in all the other channels will flash.

Notice that the **SOLO** LED below the monitoring section is flashing, indicating that there is a solo button selected in the DAW.

- Press the **SOLO** button again to deactivate it.
- Move the fader at the bottom of the Matrix channel. You will notice that the DAW's **Test** track fader is moving.

- Find the **SEL KEY** area of the centre section, located below the **DAW LAYER SELECT** buttons. These buttons define the function of the lower **SEL** key which is concerned with DAW control.

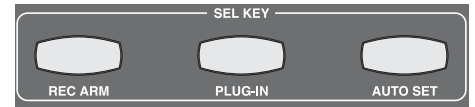

*Note that the **SEL KEY** modes have nothing to do with the upper, analogue **SEL** key.*

- Ensure that all the **SEL KEY** buttons are unlit, indicating that the lower **SEL** keys are in default mode. If any buttons are lit, press them to return to default mode.

In default mode, the lower **SEL** keys function as DAW track selectors:

- Press the **SEL** key in the channel controlling the **Test** track. You will notice that you have selected the **Test** track in the DAW.
- Press the left hand **SEL KEY** button marked **REC ARM** and press the **SEL** key in the channel controlling the **Test** track again. You will notice that this time you have record-armed the **Test** track in the DAW. Leave the track record-readied.

See Chapter 5 for details of other in-channel DAW control functions.

STEP 7: Sending Signal from the Channel Direct Output

Now that we can hear the signal and can control the DAW, we will return to examining the channel. In Step 2 we lifted the channel fader, which defines the signal level with which the channel is feeding the main busses, so the channel is already sending signal.

- Press the Focus button again. It should now be lit, indicating that you have returned to Analogue Focus mode.



- Turn channel 16's pan pot, located a little way above the upper **SEL** key, at the top of the graphic shown left, to pan the signal between the left and right speakers. The impact will be both audible and visible in the bus meters to the right of the VU's.



- Operate the **CUT** and **SOLO** buttons below the digital scribble strip. Now that we are in Analogue Focus mode, these buttons mute and solo the signal in the channel, and the buttons light to indicate that they are active.

Notice that when the **SOLO** button is pressed, both the **SOLO** symbol above the VU meters and the **SOLO CLEAR** button in the top right of the main monitoring area are lit, indicating that there is a **SOLO** or **AFL** button selected somewhere on the desk. You will have noticed that the analogue and DAW solo functions have separate centre section solo indicators.

- Leave the channel with neither the **CUT** nor **SOLO** lights lit.
- You can press the **SOLO CLEAR** button to cancel the solo.

See Page 46 for descriptions of more advanced configuration of the desk's solo feature.

The channels also feed their own individual outputs, labelled CHANNEL OUT on the Matrix back panel, which you should have connected to the inputs of your DAW.

- Adjust the channel output gain using the **CHOP** (channel output) pot, located below the **CHIP** pot. As you have left the **Test** track record-armed, you can use the input metering in your DAW to meter the signal level you are sending.

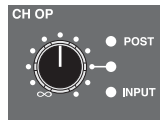

*Note that you can also meter the **CHOP** signal within the Matrix. See Page 47.*

- Using the transport controls at the bottom of the centre section, record a few seconds of the audio coming from CHANNEL OUT 16 onto the **Test** track. Once finished recording, leave the track record-armed.

Note that you may not have permission to record more than eight seconds of audio from the CD you are playing.

For information regarding how to alter the point within the channel from which you feed the channel outputs, see Page 33.

STEP 8: Setting up Artist and Control Room Headphones

You can control the mix your musicians hear from the **ARTIST MONITOR** area, located to the right of the **MAIN MONITOR** area, shown below.

You can listen to the artist’s mix using the desk’s own headphone output:

- Plug your headphones into the desk’s headphone socket, located in the trim on the right-hand side of the desk.
- In the **HEADPHONE** area below the **ARTIST MONITOR** area, press the **FROM ARTIST** button. This routes the artist’s mix, rather than the main monitor mix, to the desk’s headphones and it will light to indicate that this routing has been selected.
- You can adjust the headphone level using the **HEADPHONE** pot next to the **FROM ARTIST** button.

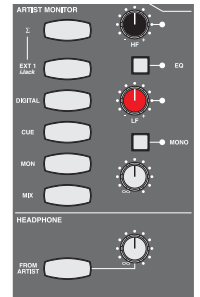

We will use the stereo cue bus to create our artist’s headphone mix:

- In channel 16, press the **CUE ST** gain pot (the lower of the two **CUE ST** pots) to switch on the send. The LED below it and to the right will light to indicate that it is on.
- Use the pot to adjust the gain, using the **CUE ST** meter to the right of the VU’s as a reference, and pan the signal using the upper pot.
- In the **ARTIST MONITOR** area, press the **CUE** button (the fourth one down on the left-hand side). This selects the **CUE ST** output as the send to the artist’s headphones. You will see the other source options available, shown above and below the **CUE** button.
- Adjust the artist’s headphone level using the grey gain pot in the lower right-hand corner of the **ARTIST MONITOR** area.
- Press the button marked **EQ**, towards the top right, which inserts a 2-band EQ into the artist’s send.
- Adjust the EQ using the **HF** and **LF** pots, located above and below the **EQ** button.
- Press the **MONO** button to sum the send to mono. Press it again to restore the send to stereo.

You can talk to your musicians using the talkback mic. You can adjust the level of the talkback mic using the **TB** pot, located above the **MAIN MONITOR** area (shown right). The talkback mic itself is just below the pot.



- Holding down the **ARTIST** button, located in the bottom right-hand corner of the centre section, routes the talkback mic to the artist’s headphones.

*Note that you will not hear the talkback mic on the desk headphone output, even though **FROM ARTIST** is pressed, as the pick off point is pre level and TB injection.*

Note that the main monitoring automatically dims when the talkback button is selected.

STEP 9: Listening Back to the DAW

In this step, we will examine the options available for listening to the DAW return.

First, we need to bring the DAW return into the channel:

- If the Master Channel is no longer assigned to Channel 16, reassign it using the upper **SEL** button.
 - Press the **INPUT FLIP** button at the top of the Master Channel to switch the channel's input from the LINE IN to the DAW RETURN. The button will switch colour from green to red, indicating the new input selection, and the LED indication to the right of the **CHIP** pot will switch from **INPUT** to **DAW**. The CD signal will also disappear for now.
- In the DAW, loop the audio you have recorded, activate the record punch-in facility and press Play. The signal you recorded in Step 7 should now appear in Channel 16, and therefore in the monitors.

Next we are going to examine a more advanced way of listening to the DAW which you will find helpful when recording:

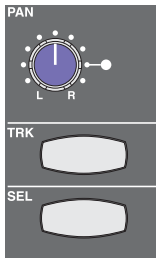

- Press the **INPUT FLIP** button again to return to monitoring the LINE IN.
- Press the **DAW MONITOR** button beneath it. This enables the **TRK** button, located below the channel strip's pan pot (shown left). Both the Master Channel's **DAW MONITOR** button and the channel strip's **TRK** button light up to indicate that DAW Monitor mode is active.
- Now press Channel 16's **TRK** button a few times and you will hear the channel's monitoring source flipping between the DAW and the CD. The colour of the **TRK** button also indicates which monitoring source is selected: green for DAW return and yellow for channel output.

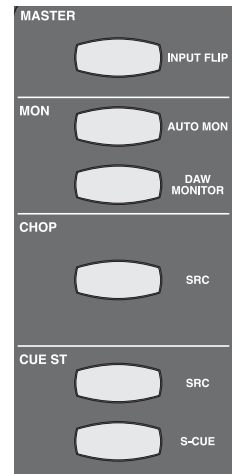

- Now press the **AUTO MON** button above the **DAW MONITOR** button. This allows the Play button to control the **TRK** button.
- Press Stop and Play a few times. You will notice that when in Play, you can only hear the DAW and when in stop the CD player comes back.

We will now create an artist's headphone mix using the SuperCue function which employs the **CUE ST** to create an advanced drop-in monitoring function: when the transport is in Play, the SuperCue sums the channel send and the DAW return. It then mutes the DAW return when in Record for a drop-in, so that the artist does not hear their own signal delayed by the DAW latency.

- In the **CUE ST** area of the Master Channel, press the **S-CUE** button (at the bottom of the above-right graphic) to activate the SuperCue monitoring function for Channel 16. It will light green to indicate that it is active.

If you listen to the artist's headphone send using the engineer's headphones, you should now hear both the audio coming from the CD player and the looped audio coming from the DAW.

- Press Record to punch in, and you will notice that the DAW return has been muted.
- You will be relieved to know that you can now stop the DAW playback!

*Note that for the **DAW MONITOR** and SuperCue functions to switch between corresponding DAW sends and returns, each DAW track output must be set to send to the Matrix channel which is feeding its input. For more details of the **DAW MONITOR** and SuperCue functions, see Pages 34 and 35*

STEP 10: Selecting a Title

For the final two steps in this tutorial (this tutorial goes up to eleven...), we will introduce the Projects system which allows you to manage the way in which Matrix is configured for a particular recording, using the Matrix Remote. There are six tabs in the Remote, the first of which (**Projects**) will be examined in this step, and the fourth of which (**Insert Matrix**) will be examined in Step 11. For the **Total Recall**, **Channels** and **About** tabs along with more detail on the **Projects** and **Insert Matrix** tabs, see Chapter 4, and for the **DAW** tab see Chapter 6.



A Project is simply a folder of recordings which are grouped together on whichever basis you choose, and a Title is a specific recording within that Project. For example, the Titles might refer to different tracks within an album, and the Project might refer to the album as a whole. All settings created within the **Total Recall**, **Channels** and **Insert Matrix** tabs are specific to their Title and therefore different Titles within a Project can have completely different settings. It is therefore essential that whenever you change any of the settings in and of these tabs, you make sure you are editing the correct Title.

The left half of the **Projects** tab contains the main Projects folder. Matrix comes with one Project, which in turn contains one Title:

- Double-click on the main **Projects** folder to expand it.
- Double-click on **Project 1** to expand the Project.
- Highlight the **Title 1** folder which appears and press the **Open Title** button at the bottom of the screen. This makes **Title 1** the Current Title - in other words it becomes the Title under which any configuration within the **Total Recall**, **Channels** and **Insert Matrix** tabs is stored.

You will notice that Project 1 and Title 1 are listed as the **Current Project** and **Current Title** at the top and bottom of the window as well as in the **Notes** section of the tab, as shown above.

You are now ready to start configuring Matrix for **Title 1**.

STEP 11: Inserting Signal Processing into the Channel

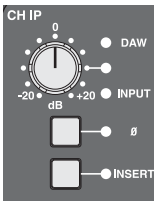

Most mixing desks have signal processing available in the channel. You will probably be aware by now that Matrix doesn't, as the outboard and DAW signal processing with which Matrix is designed to work would make in-channel processing an unnecessary and costly expense. You can, however, insert your outboard signal processing into the channel using the Insert Matrix in the Matrix Remote:

- Press channel 16's **INSERT** button, located between the **CHIP** and **CHOP** pots, shown left. Depending on your setup, the monitoring may now fall silent.

On your computer, run the Matrix Remote and select the **Insert Matrix** tab which is the fourth tab from the left. The right hand-side of the Insert Matrix tab shows you red boxes labelled "**Insert 1**", "**Insert 2**" etc. These boxes represent your analogue outboard gear you have connected to the Insert Send and Return connections on the back of Matrix. They are known as Devices. Devices are floating, which means you can freely move them into whichever analogue insert point you like.



- Start by renaming each **Device**. You can do this by right-clicking and choosing **Rename**
- Once you have named your devices use the scroll bar at the bottom, to bring **Chan 16** into view inside the Insert Matrix
- Simply click and drag the device you want and hover over the first available 'slot' in channel 16's column. Release the mouse click and it will be placed into the insert slot.

The device will then turn red in the **Device** list to indicate it is in use

For more information regarding the **Insert Matrix**, including how to make chains, see Page 77.

Congratulations on completing the Tutorial. You should now be ready to explore some of the more advanced functions of Matrix. The rest of this manual will fill in the detail wherever you need it.

This page is intentionally almost blank

Chapter 3 - Analogue Signal Flow

In this chapter we will be examining the analogue side of Matrix, focusing on its extensive routing capabilities and examining the unique Matrix automation facility. We will also cover the SSL soft keys, which affect both analogue and DAW control domains.

Introduction to Focus Modes



Matrix combines two distinct modes of operation in one control surface, providing control of both the analogue signals and the DAW functions associated with the modern recording environment. In order to accomplish this within a compact space, the console can operate in two 'Focus' modes, focusing on either the analogue or DAW control functions. These modes are called Analogue Focus and DAW Focus.

Focus modes primarily affect the channel faders and their **CUT** and **SOLO** buttons which control the analogue signal when in Analogue Focus mode, but send control messages to the DAW when in DAW Focus mode. Focus modes also affect the channel meters which normally meter the analogue signal in Analogue Focus mode but replicate the DAW track metering in DAW Focus mode. The scribble strip also functions differently in each Focus mode.

It is possible to lock the meters to either the analogue channel or DAW track signals regardless of the console's Focus mode. This is done via the Meter menu in the SSL soft keys. See Page 44 for more details.

Matrix's mode is selected and indicated by the large Focus button, located directly underneath the Master Channel, on the left of the centre section (shown right). Pressing this button swaps between Focus modes. It is lit to indicate Analogue Focus, and unlit to indicate DAW Focus.



In this chapter, we will be concentrating on Analogue Focus mode, so the Focus button should be lit.

See Page 84 for more on Focus modes.

Operating Principles

The Matrix control surface is divided into two parts: the 16 channel strips make up the left hand side of the console while the 'Centre Section' (which houses all the out-of-channel controls, along with the Master Channel (see next page), makes up the right hand side of the console.

The Matrix channel strip (shown left) is split into two sections: the top section, from the channel metering down to the digital scribble strip, controls most of the analogue side of the desk (signal routing and source selection etc), and we will therefore focus our attention there. The lower section of the channel strip, from below the digital scribble strip down, is more focused on DAW control. However, this section includes the **CUT** and **SOLO** buttons as well as the fader, all of which function in both analogue and DAW Focus modes.

The Master Channel Strip

In addition to the controls within the physical channel strip, there is another section on Matrix which is used to access channel strip functions. This is the Master Channel strip which appears in the top left-hand corner of the desk's centre section (shown right). While each line input has a dedicated channel strip, all 16 channels share the Master Channel, its controls accessing the channel strip to which it is assigned.

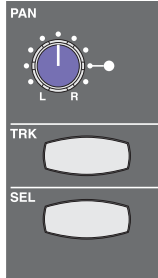

To assign the Master Channel to a particular channel strip, press the **SEL** button located at the bottom end of the analogue section of the channel strip in question, just above the numeric display.

*Note that the DAW Control section of the fader strip also has a **SEL** button just above the scribble strip which cannot be used for selection to the Master Channel. Use of this **SEL** button is described on Page 87.*

To assign the Master Channel to multiple channel strips, hold the left-most **SEL** button of the main part of your intended selection and then press its right-most **SEL** button. This assigns both selected channels plus all the channels in between. Pressing the **ALL** key will select all 16 channels, enabling you to perform global routing or source selection.

When multiple channels are assigned to the Master Channel, the LEDs on the Master Channel will assume the status of the lowest selected channel. Any switching then performed will apply that setting in all selected channels to correspond to the status to which the lowest channel has been switched. For example, if Channels 1 to 5 are assigned to the Master Channel and Channel 1's **CUE ST** source is set to **INPUT**, switching the Master Channel **CUE ST** source from channel input to **POST** fader will set all five channels' **CUE ST** source to **POST** fader, regardless of what their status was before the switching.

If the **SET** button above the **ALL** button in the Master Channel is activated while an array of channels is selected, any switching action on any of the physical channel strips (as opposed to the Master Channel) such as muting a send, will be replicated across all selected channels, even if the channel strip used to trigger the switch is not part of the selected array. Any switching then performed will unify that setting on all selected channels to correspond to the status to which the operated channel has been switched. The **SET** button will light up to indicate that it is active.

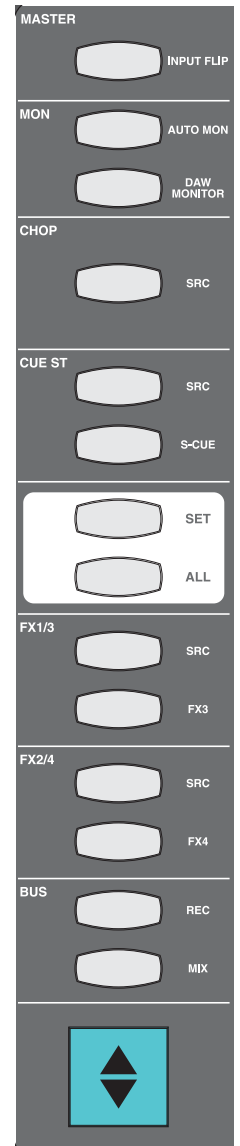

The Digital Scribble Strip

The digital scribble strip that runs across the centre of the desk consists of two display rows. By default, the top row contains labels associated with the channel faders, and is therefore Focus mode dependent: In Analogue Focus mode it displays the channel names defined in the **Channels** tab of the Matrix Remote (switching to a momentary display of the fader value in dB when a fader is moved), whereas in DAW Focus mode the top row normally displays the DAW track names.

Similarly, the bottom row of the scribble strip is associated with the V-Pot located beneath the scribble strip (see Page 86). When Matrix is assigned to a layer controlling a DAW, the bottom row of the scribble strip displays either the name or the value of the parameter controlled by the V-Pot. When controlling Pro Tools, the scribble strip only displays the name of the V-Pot. For DAWs controlled via the MCU protocol, please refer to their control surface documentation for full details of their scribble strip displays and messages.

See Page 116 for a description of the scribble strip in CC layers.

Total Recall LEDs

Most of the pots on the Matrix control surface have LEDs positioned immediately to their right. These are Total Recall LEDs and are used for manually resetting the desk controls to a saved snapshot. You will find a full description of their function on Page 70, but for now, all you need to note is that any pot with a Total Recall LED can have its position saved and recalled using the desk's Total Recall function.

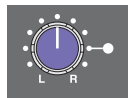

The Channel Strip

Channel Inputs

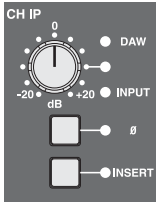

Each channel on Matrix has two line inputs: The first input would normally be sourced from the output of a mic preamp, DI box or instrument and is labelled on the back of the desk as 'LINE IN'. The second input would normally be fed from the output of the DAW and labelled as 'DAW Return'. The Channel Input (**CHIP**) is sourced from the line in by default, and it is this input that is referred to wherever the **INPUT** label appears on the desk. To swap inputs to the DAW return, press the **INPUT FLIP** button at the top of the Master Channel. The LEDs to the right of the gain pot indicate which input is selected, as does the colour of the **INPUT FLIP** button (Green for **INPUT**, red for **DAW**).



Once you have selected your input, it then has a ± 20 dB gain trim, indented in the centre at unity gain with a Total Recall LED, and phase reverse (\emptyset) button.

The post-gain channel signal is always available to the Insert Matrix. Pressing the **INSERT** button brings the return from the Insert Matrix back into the channel, effectively dropping into the signal chain whatever processing is assigned to it from the Insert Matrix (see Page 77).

*Note that if you press the **INSERT** button when nothing has been routed to that channel from the Insert Matrix, the channel strip will be silent beyond the insert point.*

Channel Outputs

Direct Channel Outputs

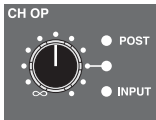

The individual Channel Outputs (**CHOP**), are designed to be used to feed the inputs of a DAW, and appear on the desk's rear panel as CHANNEL OUT. The **CHOP** has a gain trim with an indent in the centre at unity gain, and a Total Recall LED. It can be fed from three different places: line-in pre-gain (**INPUT**), pre-fader (post-insert) or **POST**-fader, as selected by the **SRC** button in the **CHOP** section of the Master Channel. Pre-fader is the default setting.

The line-out's source is indicated by the LEDs to the right of the gain pot and by the colour of the **SRC** button:

Signal Source	LED indication	SRC button colour
Pre-fader, post-insert (default)	No LED	Unlit
From the line-in, pre-gain	INPUT is lit	Red
Post-fader	POST is lit	Yellow

REC and MIX Busses

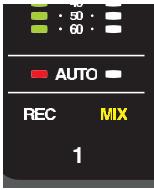

In addition to the **CHOP**, the channel's main fader can feed the record and/or mix bus. These are selected using the **REC** and **MIX** bus buttons at the bottom of the Master Channel which light up to indicate the presence of routing. This routing is also indicated by the lighting of the **REC** and **MIX** symbols at the bottom of the meter section above the channel (shown left). You will notice that throughout the desk, references to the **REC** bus are red, references to the **MIX** bus are yellow, and references to the **MON** bus are green.



The signal level being sent to the record and mix busses is controlled by the fader at the bottom of the channel. The channel's feed to the record and mix busses is panned using the pan pot towards the bottom of the routing section of the channel strip (shown below), which includes a Total Recall LED. The pot is indented in the middle, where the signal is feeding both the left and right busses equally.

DAW Monitor Mode

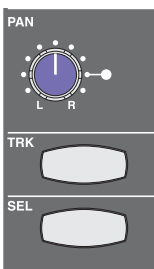

When **INPUT** has been selected as the channel source, pressing the **DAW MONITOR** button in the Master Channel (shown right) enables the **TRK** button, located below the channel strip's pan pot (shown left) and configures the channel for recording following the classic in-line style of previous generation SSL consoles. The signal received from the input is routed through any processing applied via the Insert Matrix and then to the DAW via the channel output.



With **DAW MONITOR** mode active, pressing **TRK** switches the monitoring source for that channel between the CHANNEL OUT (post-gain) output (the DAW send) and the DAW RTN input (pre-gain).

Both the Master Channel's **DAW MONITOR** button and the channel strip's **TRK** button light up to indicate that DAW Monitor mode is active. The colour of the **TRK** button also indicates which monitoring source is selected: green for DAW return and yellow for channel out.

When the **DAW MONITOR** mode is active, full zero latency drop in and Record monitoring is available via the **AUTO MON** button above it. **AUTO MON** allows the desk to take control of the **TRK** buttons, automatically switching the monitoring source on any channels in **DAW MONITOR** mode depending on the status of the DAW transport and track record tally:

- When the transport is idle the monitoring source for these channels will be the channel output.
- When the transport is in Play the monitoring source will be the DAW return.
- When the DAW (and the DAW track associated with the channel) is in record, the monitor source flips back to the channel output.

*Note that for the **DAW MONITOR** function to switch between corresponding DAW sends and returns, each DAW track output must be sending to the Matrix channel which is feeding its input.*

*Note also that in order to use **DAW MONITOR** mode, the channel input must be set to **INPUT**, and the **CHOP** source must not be post-fader.*

Cut and Solo

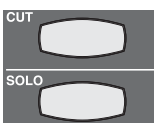

Above the fader, there is a **CUT** switch which immediately mutes the channel's output, and a **SOLO** button which mutes all other channels, leaving that channel as the only signal reaching the monitors.

See Pages 43 and 45 for details of the different solo and cut modes available on Matrix.

Auxiliary Sends

Matrix has six aux sends: one stereo cue and four mono effects (FX) sends.

Stereo Cue Send

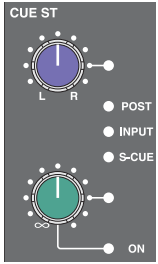

The send to the stereo cue bus has a gain trim and pan pot, both of which have Total Recall LEDs. Pressing the gain pot switches the send on and off. The **ON** LED below the pot will light to indicate that it is on. The pan pot is indented in the middle, where the signal is feeding both the left and right busses equally.

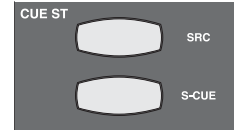

The stereo cue bus can be fed from four places: line-in pre-input-selection, pre-fader (post-insert), post-fader or via SuperCue. The first three of these are selected by the **SRC** button in the **CUE ST** section of the Master Channel, with pre-fader being the default setting.

The source is indicated by the LEDs between the pan and gain pots, and by the colour of the **SRC** button:

Signal Source	LED indication	SRC button colour
Pre-fader, post-insert, (default setting)	No LED	Unlit
From the line-in, pre-gain	INPUT is lit	Red
Post-fader	POST is lit	Yellow
SuperCue monitoring (see below)	S-CUE	S-CUE is Green*

SuperCue

When **CUE** is selected as the source in the **ARTIST MONITOR** area of the centre section (see Page 40), SuperCue can be used to control the artist’s headphone feed to provide full zero latency drop in and record monitoring for the artist. It works in conjunction with the transport controls, summing the channel send and the DAW return when in Play, and automatically muting the DAW return when in Record for a drop-in. The **S-CUE** button in the Master Channel overrides the source selection made by the **SRC** button.

Note that for the SuperCue function to switch between corresponding DAW sends and returns, each DAW track output must be sending to the Matrix channel which is feeding its input.

** Note that you can still cycle through the **SRC** options when in SuperCue. However, the source selection indicated by the **SRC** button will not become active until the **S-CUE** button has been deselected. You will notice that if you cycle through source options while in SuperCue mode, the **SRC** button colour changes but the LED indication in the channel does not.*

32-Track Mixdown

When Matrix is being used for mixdown, and the channel is therefore being fed from the DAW return the main channel input (‘LINE IN’) can be used to create an extra input channel, allowing for 32-track mixdowns on one Matrix. This is done by selecting **INPUT** as the source of the stereo cue, as described above, and then pressing **TO MIX** within the **CUE ST** area of the desk’s centre section. FX sends can then be fed from the **CUE** bus, enabling external processing to be assigned to the **INPUT** signal rather than DAW return signal, as described below.

*Note that when using the **CUE ST** bus this way, the DAW returns should be fed by those signals requiring routing to the Insert Matrix.*

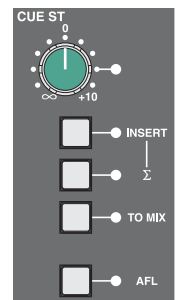

FX Sends

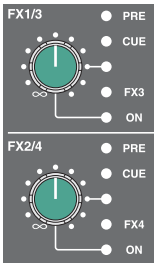

Matrix has four mono FX sends. Only two FX busses can be fed at any one time by a particular channel, using the two gain pots (which have Total Recall LEDs). By default, the sends to FX busses 1 and 2 are active. Pressing the **FX3** button in the Master Channel switches the **FX1/3** signal feed from the FX1 bus to the FX3 bus, and this routing is indicated by the **FX3** LED to the right of the gain pot being lit. Similarly, pressing the **FX4** button in the Master Channel switches the **FX2/4** signal feed from the FX2 bus to the FX4 bus, and this routing is indicated by the **FX4** LED to the right of the gain pot being lit.

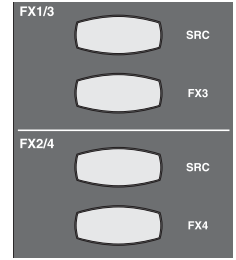

Pressing the gain pot switches the send on and off. The **ON** LED below the pot will light to indicate that it is on.

The FX sends are fed post-fader by default, but have two alternative sources: the pre-fader (post-insert) signal and the **CUE** bus.

*Tip: Signal processing can be added to stereo cue sends when they are being used as additional mixdown channels (see previous page) by sourcing the FX busses from the **CUE** bus.*

*Tip: When using SuperCue (see previous page), you can avoid sudden loss of the FX sends signal processing in the **ARTIST MONITOR** during drop-ins by sourcing the FX busses from the **CUE** bus.*

The source is selected using the **SRC** button in the **FX1/3** and **FX2/4** sections of the Master Channel, and is indicated by the LEDs above and to the right of the send gain pot, as well as by the colour of the **SRC** button:

Signal Source	LED indication	SRC button colour
Post-fader (default setting)	No LED	Unlit
Pre-fader	PRE is lit	Green
Stereo Cue Send	CUE is lit	Red

When an **FX3** or **FX4** bus is pressed, the source selection and gain for that signal feed remain unchanged.

The Centre Section

Master Bus Controls

The master controls for the mix, record, cue and FX busses are found in the top right corner of the Matrix centre section. Each bus has its own gain pot with a Total Recall LED. The gain pots trim the signal by ± 24 dB and are indented in the centre at unity gain.

The Mix Bus

The **MIX** bus has its own dedicated insert circuit which is separate from the channel routing in the Insert Matrix. The **INSERT** button below the gain trim routes the bus through the MIX INS SEND and RTN connections. By default, the return from the insert will then feed the main bus output. However, the summing (Σ) button below the **INSERT** button sums the insert return and the original bus feed together.

*Note that pressing the **INSERT** button without anything connected to the MIX INS SEND and RTN will leave the mix bus silent, unless the Σ button is selected.*

Note also that if the MIX INS SEND and RTN connections are not required for signal processing, pressing the Σ button enables the return connections to be used as a direct stereo input to the bus.

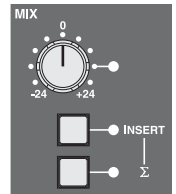

The Record Bus

The **REC** bus has its own dedicated insert circuit which is isolated from the channel routing in the Insert Matrix. The **INSERT** button below the gain trim routes the bus through the REC INS SEND and RTN connections. By default, the return from the insert will then feed the main bus output. However, the summing (Σ) button below the **INSERT** button sums the insert return and the original bus feed together.

*Note that pressing the **INSERT** button without anything connected to the REC INS SEND and RTN will leave the record bus silent, unless the Σ button is selected.*

Note also that if the REC INS SEND and RTN connections are not required for signal processing, pressing the Σ button enables the return connections to be used as a direct stereo input to the bus.

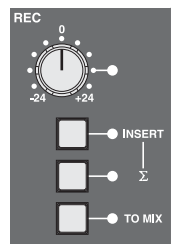

The **REC** bus can be routed to the **MIX** bus by pressing the **TO MIX** button below the Σ button.

The Cue ST Bus

The **CUE ST** bus has its own dedicated insert circuit which is isolated from the channel routing in the Insert Matrix. The **INSERT** button below the gain trim routes the bus through the CUE INS SEND and RTN connections. By default, the return from the insert will then feed the main bus output. However, the summing (Σ) button below the **INSERT** button sums the insert return and the original bus feed.

*Note that pressing the **INSERT** button without anything connected to the CUE INS SEND and RTN will leave the cue bus silent, unless the Σ button is selected.*

Note also that if the CUE INS SEND and RTN connections are not required for signal processing, pressing the Σ button enables the return connections to be used as a direct stereo input to the bus.

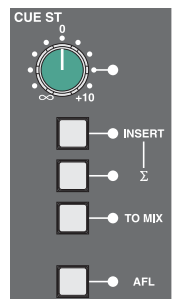

The bus can be routed to the **MIX** bus by pressing the **TO MIX** button below the Σ button.

*When using the desk for 32-track mixdown (see Page 35), the **CUE ST** bus must be routed to the **MIX** bus.*

The send signal can be auditioned on the main monitoring by pressing the **AFL** button below the **TO MIX** button. There is an LED to the right of the button which lights to indicate that **AFL** is on. (See Page 39 for more on **AFLs**.)

Digital I/O

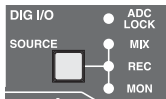

Matrix has one stereo digital output which feeds both AES/EBU and S/PDIF connections on the desk's rear panel. This output is controlled by the **Digital I/O** area of the centre section, located immediately below the **MIX** bus master. If a digital input is connected, then Matrix will lock its internal clock to it. The LED in the top right corner of the **Digital I/O** area, labelled **ADC LOCK**, lights to indicate that the desk is locked to the incoming signal.

The digital output can be sourced from the **MIX** bus, **REC** bus, or from the monitor signal (pre-monitor level). The **SOURCE** button cycles through these options, and LEDs to the right of the button indicate which source is selected. If there is an incoming digital signal, the output will replicate its sample rate. If no digital input is detected the output sample rate will default to 48kHz - it is recommended that an external reference is always connected to ensure that Matrix's digital I/O remains synchronised to the DAW.

See Page 45 for a description of digital input selection.

The FX SEND Busses

Each of the four FX signals can be auditioned on the main monitoring by pressing the **AFL** button below the gain pot. There is an LED to the right of the button which lights to indicate that **AFL** is on. (See Page 39 for more on **AFLs**.)

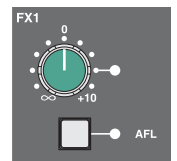

Stereo Returns

The outputs of the devices connected to the four FX sends would normally be brought back into Matrix using the line-level Stereo Returns, labelled **ST RET 1** to **ST RET 4**. These are located below the **REC**, **CUE ST** and **FX** bus master controls.

The top three buttons allow you to route the signal to the **MIX**, **REC** and **CUE ST** busses. An LED to the right of each button lights to indicate the presence of this routing.

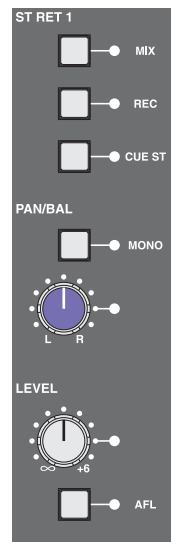

The signal can be summed to mono by pressing the **MONO** button below the three routing buttons. An LED to the right of the button lights to indicate that the signal has been reduced to mono.

Below the **MONO** button is a pot which functions as a balance pot for stereo signals and a pan pot for mono signals, and at the bottom of each **ST RET** area there is a gain trim. Both of these pots have Total Recall LEDs.

The signal can be auditioned on the main monitors by pressing the **AFL** button below the gain pot. There is an LED to the right of the button which lights to indicate that **AFL** is on. (See Page 39 for more on **AFLs**.)

Monitoring

Control Room Monitors

The **MAIN MONITOR** area of the Matrix centre section is located to the right of the Master Channel. The blue pot towards the bottom left of the area is the volume control for the main monitors, and beneath it are two buttons. The left button, labelled **DIM**, immediately reduces the volume of the monitoring. The amount of gain reduction introduced by the **DIM** button ranges from -3dB to -30dB and is controlled by the **DIM** pot, which is the middle of the three grey pots above the main volume control. The button to the right of the **DIM** button, labelled **CUT**, mutes the monitoring. Both the **DIM** and **CUT** buttons light up to indicate that they are active.

In the right half of the monitoring area are 10 buttons, which will be described in ascending order:

Pressing **MINI** swaps the monitoring output from the main monitors to the near-field monitors. The mini's have an independent volume control which is the bottom of the three grey pots, immediately above the main monitor volume control. To return to hearing the main monitors, press the **MINI** button again. Pressing **MONO** sends a left-right summed signal to both speakers. Pressing and holding **ØL** inverts the phase of the left-hand monitor signal. You can monitor the stereo difference (L-R) signal by pressing **ØL** when the **MONO** button has been selected.

The next five buttons above the **ØL** button form the source selector for the monitor bus. These include the **MIX** and **REC** busses along with three external inputs described below: **DIGITAL**, **EXT2** and **EXT1**. Each buttons lights when active.

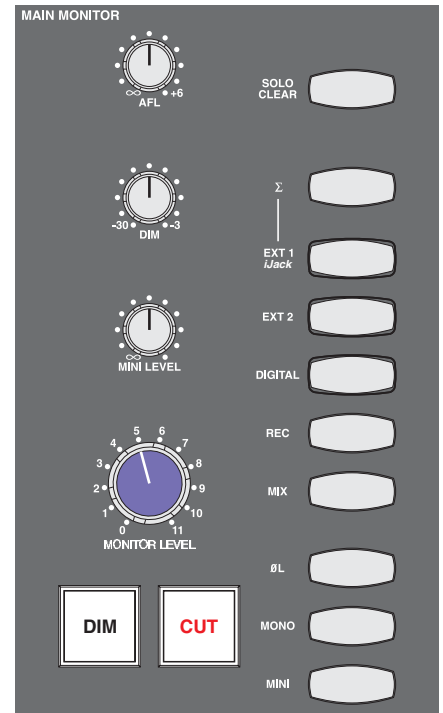

*Note that while the other buttons light yellow, the **REC** bus lights red in keeping with its colour coding.*

Normally these buttons cancel each other (in other words, if you select one source, the previously selected source is automatically deselected). However, the summing button (Σ), located immediately above the five source selector buttons, removes the intercanceling feature and instead sums all selected inputs, enabling multiple sources to be monitored simultaneously. Deselecting the Σ button cancels all monitoring sources and returns the monitoring to intercanceling mode.

The top button in the monitoring area, labelled **SOLO CLEAR**, clears any **SOLO** or **AFL** buttons that are active on the desk, restoring the monitoring source selection in the buttons beneath it. The **SOLO CLEAR** button lights to indicate that there is a channel or bus in solo or AFL mode somewhere on the desk, as does the **SOLO** light located above the VU meters.

*Note that the small light marked **SOLO** beneath the **MAIN MONITOR** area displays the solo status of the DAW, not the analogue channels.*

External Monitoring Inputs

Matrix allows up to three external audio sources to feed the monitoring - two analogue and one digital. On the console, these are labeled **DIGITAL**, **EXT1** and **EXT2**, and their connections are described in Chapter 1. If an MP3 player or iPod is connected to the ijack socket in the consoles right-hand trim, this signal will replace the **EXT1** signal.

After Fade Listen (AFL)

The pot labelled **AFL** located at the top of the monitoring area sets the main monitoring volume for the stereo AFL function. Pressing any **AFL** button on the centre section will replace the current feed to the monitors with the post-level signal (and in the case of the Matrix channels, post level and pan) associated with that **AFL** button. Pressing multiple AFLs will sum the selected signals together. AFLs can be cancelled by pressing the **SOLO CLEAR** button or by deselecting any active **AFL** buttons. Centre section AFLs are unaffected by the solo monitoring soft key options detailed on Page 43.

Artist's Monitoring

Matrix has an additional output for the artist's headphones, which is controlled by the **ARTIST MONITOR** area of the centre section, to the right of the **MAIN MONITOR** controls. The six buttons on the left hand side select the signal which is feeding the artist's monitoring. The sources available are (from bottom to top) the **MIX** bus, the control room monitor output (**MON**), the **CUE** bus, the desk's **DIGITAL** external monitor input (see Page 45), and the first of the two analogue external monitor inputs (**EXT 1**). Each button lights to indicate which is active.

*Note that while the other buttons light yellow, the **MON** bus lights green in keeping with its colour coding.*

Normally these buttons cancel each other. However, the summing button (Σ) located immediately above the five source selector buttons, removes the intercanceling feature and instead sums all selected inputs, enabling multiple sources to be monitored simultaneously. Deselecting the Σ button cancels all monitoring sources and returns the artist's monitor to intercanceling mode.

The **ARTIST MONITOR** has available a 2-band EQ with high-pass and low-pass shelving controls and Total Recall LEDs. This is located in the top right of the **ARTIST MONITOR** area, and can be switched into the circuit by pressing the **EQ** button located in between the **HF** and **LF** pots. Both EQ pots are indented in the centre.

The pot in the bottom right is a gain control for the artist monitor output. The **MONO** button above it reduces the feed to mono.

Engineer's Headphones

There is an engineer's headphone output located in the trim on the right hand side of Matrix, close to the large navigation wheel. It is controlled by the area above the transport counter, consisting of a **HEADPHONE** gain pot and a **FROM ARTIST** button which switches the headphone feed from the control room monitor mix to the artist's monitor mix (see above). The button lights to indicate that the feed has been switched to the artist's mix.

While the **FROM ARTIST** button is not selected, the headphone signal follows the source selection in the **MAIN MONITOR** area, along with the **OL** and **MONO** buttons, but is not affected by the **DIM**, **CUT**, **MINI** or level controls.

Conversely, when **FROM ARTIST** is selected, the engineer's headphone signal follows the **ARTIST MONITOR** source selection, **EQ** insert and **MONO** button, but is not affected by the level control.

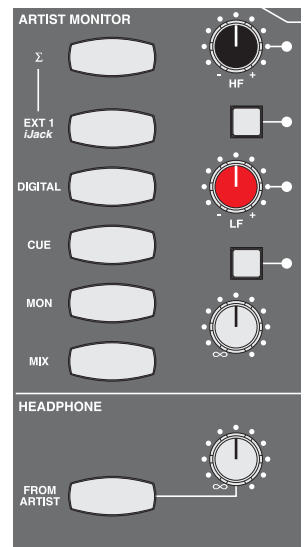

Talkback



The engineer can talk to the artist by pressing and holding the **ARTIST** button located to the left of the large navigation wheel in the centre section. This sends the signal from the desk's inbuilt talkback microphone to the artist's monitor feed.

The talkback microphone is located above the **MAIN MONITOR** area of the centre section (shown right). Its level is set by the **TB** gain trim immediately above it. When it is pressed, the **DIM** function is automatically activated in the main monitoring.

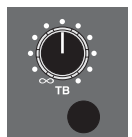

The action of the talkback switch may be changed from momentary to latching by engaging the "**TB Latch**" switch within the **SSL > MonOpt** menu.

*Note that the talkback function can also be assigned one of the two rear panel foot switch inputs via the **DAW** tab in the Matrix Remote. See Page 114 for more details.*

*Note also that the talkback does not feed the engineer's headphone signal, even when the **FROM ARTIST** button has been selected.*

Metering

At the top of Matrix is a penthouse where you will find the metering for all of the channels and busses:

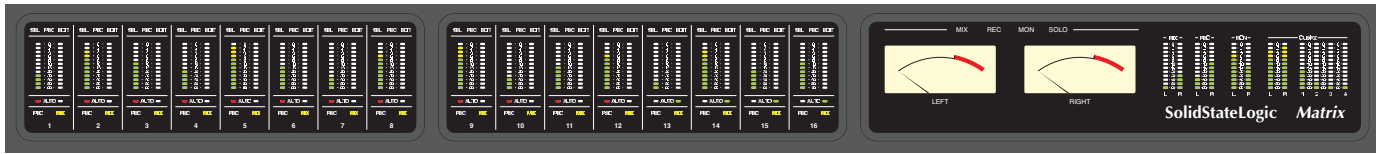

Channel Meters

Each channel has a pair of 12-segment meters. In DAW Focus mode, the second meter allows stereo DAW channels to be metered in the channel strip, for those HUI protocol DAWs which support this. In Analogue Focus mode, the right-hand meter is blank and the left-hand meter displays the signal level of the channel.

The **SEL**, **REC** and **EDIT** symbols above each meter display DAW track status and are described in Chapter 5. The **AUTO** lights below each meter area are used for automation and Total Recall in Analogue Focus mode, and for DAW Automation status (HUI protocol DAWs only) in DAW Focus.

Normally the channel meters follow the desk Focus mode. However, via the Meter menu in the SSL soft key set, the channel meters can be locked to the Analogue Channel or DAW metering regardless of the current Focus mode (see Page 44).

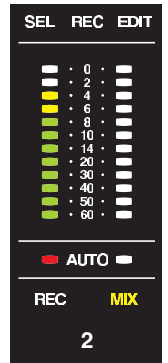

The **AUTO** indicators in Analogue Focus mode are described on Pages 46 and 66.

The **REC** and **MIX** symbols at the bottom of the meter area are concerned with bus routing and are described on Page 34.

See Chapter 5 for more on DAW protocols.

Bus Meters

The **MIX**, **REC**, **MON**, **CUE ST**, and **FX 1-4** busses all have their own 12-segment meters located at the right-hand end of the penthouse, displaying their post-fader signal level. The stereo busses all have separate meters for left and right.

VU Meters

There is also a pair of VU meters located in the left-hand side of the centre section penthouse. Their source is selected in the **MAIN VU SELECT** area of the centre section, below the right-hand VU meter. The three sources available are the **MIX**, **REC** and **MON** busses, and the selected source will be indicated by its button being lit, and also by the appropriate symbol above the meters being lit. The top button in the **MAIN VU SELECT** area, labelled **-10dB**, attenuates the signal feeding the meters by 10dB to avoid pinning the needles to the end stop with over normalised DAW mixes.

The VU meters are unaffected by solo mode, and will keep metering the selected source even when the **SOLO** symbol above them is lit.

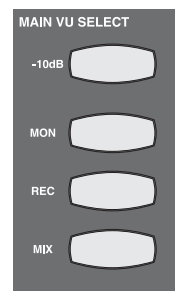

See Page 44 for details of metering options.

Devices and Chains - Front Panel Control

Your 16 pieces of outboard gear that are connected to the Insert Send and Returns connections can be routed to the desired Insert Point from the front panel. Equally, any change you make in the Matrix Remote browser, will be mirrored on the Matrix itself.



Please note that if the **IN-LINE** button is active, the **DEVICES** and **CHAINS** buttons will function as **V-SOLO** and **V-MUTE** commands instead. See Chapter 5 for more information on these modes.

Devices

Pressing the **DEVICES** key will hi-jack the LCD scribble strip on the right-hand side of Matrix to display the names of your 16 pieces of analogue outboard gear.

The two rows of eight buttons above and below the labels will indicate if that particular **DEVICE** is available.

If the button is lit (yellow) that device is available. If the button is not lit, it is already inserted across a channel.

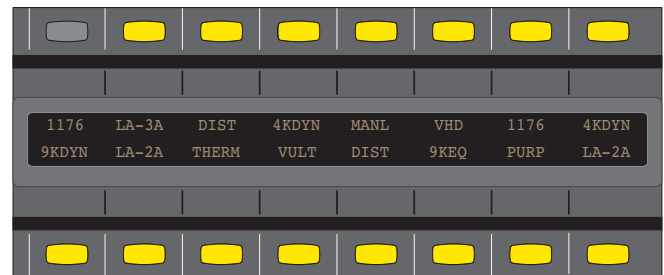

From this point, you can route outboard gear to each channel. Simply press the upper **SEL** key on the channel you want to insert something on and then press of the button corresponding to the device you want to insert.

That button will now unlight and the text will appear on the main LCD display, underneath the channel name. You can follow the same procedure to insert devices on other channels.

Building Chains On The Fly

The Matrix will allow you to use up to 6 devices across a single channel's insert point. With the **DEVICES** button still active, go to a channel where you already have a single device insert across a channel. For example, we already have our "1176" device inserted on the Bass channel but we want to put a "4K EQ" after it. To do this, we use the Navigation arrows.

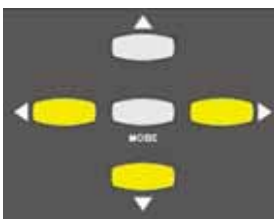

Press the **DOWN** arrow. Where the text displayed "1176", you will now see a "*". This indicates the slot is available and all you need to do is press one of the 16 devices corresponding to the device you want to insert.

To further aid recognition of what you are doing, the two character **MODE** display will change to read "- 2". This signifies that you are on the second slot of that channel.



The up and down arrows will allow you to move between slot numbers on a channel. You can only move down to the next available slot when you have filled the current slot. The bottom right of the **MODE** display will display a small dot '.' to indicate when a particular channel has a device inserted on the next slot down.

The left and right arrows will allow you to move the upper **SEL** key to select the channel you want (or just press the desired upper **SEL** key directly).

Inserting Preset Chains

Any **CHAINS** of devices you have previously saved can be inserted using the **CHAINS** button (see “Chapter 4 - Matrix Remote” for creating preset chains).

To insert a preset **CHAIN**, first ensure you have pressed the **CHAIN** button. The LCD on the right-hand side of Matrix will now change to show the names of any Preset Chains you have stored on the top row, with additional << and >> keys.

The button directly above the name Preset Chain will light yellow if available or will be unlit if already in use.

Like with Devices, use the upper **SEL** key to selected the desired channel and then press the button directly above the desired Chain name. The bottom row of the main scribble strip will now display the name of the Chain below the channel name.

If you have a channel that has 2 or more devices on it but you have not saved it as a Preset Chain, the bottom row of the main LCD scribble strip will display the name of the first device in the first slot.

At the same time, the bottom row of the right-hand LCD scribble strip will display which devices you have in that particular chain (providing that channel is still selected).

Removing Assigned Devices

When in either **DEVICES** or **CHAINS** mode, if a device/chain you want to use is already in use, the button does not light. You can see which channel it is already in use on by simply pressing it. The device label will change to display the channel number e.g. “Chan 10” and the **MODE** display will change to indicate the slot it is currently inserted on.

To remove the device simply press and hold the desired device button until it re-lights yellow. It is now available to insert using the normal method.

SSL Soft Keys

Soft keys are buttons which can have different functions assigned to them, depending on which soft key set is active.

There are a number of Matrix settings which are accessed via the SSL set of soft keys. The soft key area of the desk is located below the counter display in the centre section, and comprises 16 buttons above and below the digital scribble strip which runs across the whole desk.

The scribble strip in between the button rows indicates what functions are currently assigned to them: the upper row of the display refers to the row of buttons above it, and the lower display to the row of buttons below it.

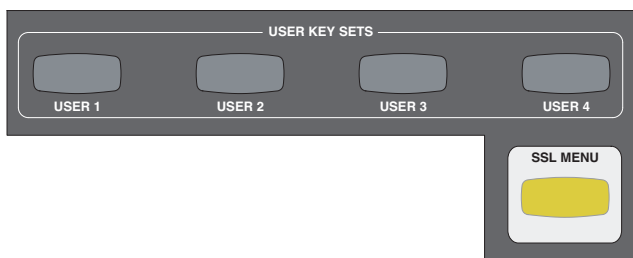
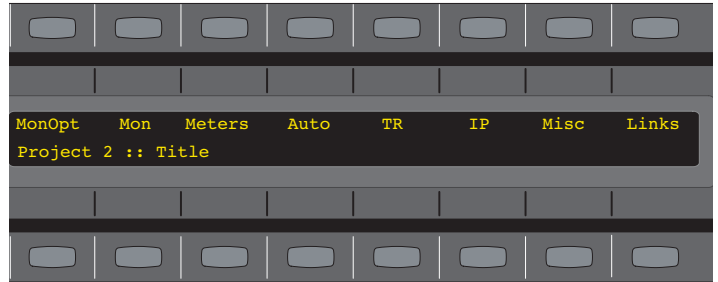

There are six sets of soft keys, comprised of five user-definable sets and the SSL set. The soft key set which is currently assigned to the soft key area is selected using the **SOFT KEY SETS** buttons, located on the right-hand side of the centre section, below the main soft key area (shown left). The SSL set is selected by pressing the **SSL** button, below the **USER 1-4** buttons. It will light to indicate that it is selected. To exit the SSL soft keys and return to the previously selected User set, press the **SSL** soft key button again.

*Note that the **SSL** button overrides the **USER** buttons. However, the previously selected **USER** set indication is retained along the top row of **SOFT KEY SETS** buttons as a reminder of which set will reactivate when the SSL set is deactivated.*

For a description of the user-definable soft keys, see Page 107.

The SSL soft keys are arranged in menus, with the top row of soft keys acting as menu selectors and the bottom row accessing functions within the currently selected menu.

There are eight menus of SSL soft keys, labelled: MonOpt, Mon, Meters, Auto, TR, IP, Misc and Links. The settings configured within these menus are detailed over the following pages.

When no soft key menus are active, the soft key display indicates the Current Project and Title (see Page 49).

MonOpt Soft Keys

The MonOpt menu in the SSL soft keys is used to configure the solo monitoring:

SIP and AFL

By default, **SOLO** buttons are destructive, muting all channels not solo enabled. This means that channel sends (both CHOP's and aux sends) sourced from the input or pre-fader signal remain unaffected by solos, but are affected when sourced post fader, along with the feeds to the **MIX** and **REC** busses. This is known as Solo-In-Place (SIP), which is the default channel solo mode. However, if the InpCut option in the Misc soft key menu is enabled (see Page 45), pre fader sends will also mute when a solo mute is received.

Pressing the AFL button switches the solo buttons to be non-destructive, by routing the post channel, post pan signal to a separate stereo mix bus, leaving the existing bus feeds and post fader sends unaffected by the **SOLO** button, with only the main monitoring being affected.

*Note that in AFL mode, the **CUT** buttons do not light when a **SOLO** button is selected, indicating that the soloing is not affecting other channels' outputs.*

Mom and Alt

By default, solo buttons 'latch', meaning that when one channel is in solo, pressing a second **SOLO** button adds that channel to the first rather than cancelling the original channel.

Pressing MOM ('momentary') causes the **SOLO** buttons to deactivate when released. They therefore need to be held down in order to remain in solo mode. More than one button can be held down simultaneously.

Pressing Alt prevents the **SOLO** buttons from latching, introducing an interCancellation between **SOLO** buttons: pressing a second **SOLO** button cancels the first **SOLO**. More than one channel can still be put in solo mode by simultaneously pressing multiple **SOLO** buttons.

When in Alt or MON mode, press the currently selected mode button to return to default (latch) mode.

Note that these options affect the channel strip solo buttons, not the centre section AFLs which are always in latch mode.

*Also note that in order for the fader or **CUT** and **SOLO** buttons to affect the analogue signal, Matrix must be in Analogue Focus mode (or in DAW Focus mode with **IN-LINE** active and the relevant channel swapped - see Page 86).*

When the Sub0dB button is lit, the LFE channel is attenuated by 10dB. This is a requirement when mixing for SACD or any other format that requires unity gain on the LFE channel.

TBLatch will change the operation of the **ARTIST** talkback button from momentary to latching.

Mon Soft Keys

The MON menu allows you to cut or solo individual monitor outputs in your 5.1 setup. By default, pressing any of the Left, Centre, Right, LSurr, RSurr, Sub buttons will cut the relevant output. Pressing the SOLO button first will change the function of the buttons from Cut to Solo mode. The Mtr5.1 button switches between 5.1 and stereo monitor outputs. The Mtr5.1 button also changes the MIX, REC and MON meters on the meterbridge from 3 stereo meters to a single 5.1 meter.

Meters Soft Keys

The Meters menu in the SSL soft keys is used to configure the analogue channel meters. Once this menu has been selected, the eight lower buttons in the soft key area are in three groups: buttons 1 and 2 prevent the meters from following the console's Focus mode by locking them to either the analogue or DAW signals, buttons 3 and 4 provide peak hold options, and buttons 5 to 8 provide meter source options for analogue metering. All buttons cancel out other selections made within that group, and can be returned to their default state by pressing the currently selected option:

Note that additional meter options are available in the SSL Misc menu. See Page 45 for details.

Note that when metering DAW tracks, the metering is configured and controlled by the DAW, not the SSL soft keys. The DAW control surface documentation will provide details on how to clear overload indicators and how to enable peak hold options.

Focus Options

By default, the meters follow the console's Focus mode, displaying the analogue channel levels in Analogue Focus mode, and the levels in the DAW tracks in DAW Focus mode. Pressing Analog causes the meters to stay with the analogue channel levels, and pressing DAW causes the meters to stay with the DAW track levels, regardless of the console's Focus mode.

Peak Hold Options:

Peak Hold is where the top segment lit by any momentary peak levels remains lit once the level drops. By default, the meters do not have a peak hold. Pressing Peak introduces a 3 second peak hold, and pressing HOLD introduces an infinite peak hold which can be reset by cancelling the Hold button.

Meter Source Options:

There are four source options for the channel meters: CHIP (channel input post-gain), CHOP (channel output), DAW Return (DAW return pre-gain), and Post (post fader).

Auto Soft Keys

The first three soft keys in the Auto menu enable the analogue channel levels to be controlled via MIDI Volume (CC7) messages received from a DAW or other external MIDI controller. By creating additional MIDI tracks in the workstation the analogue channels can be automated using faders in the DAW layer as MIDI controllers for the matrix channels and writing volume automation data into the DAW project. These soft keys are channel-specific, affecting the channel(s) selected using the upper **SEL** key.

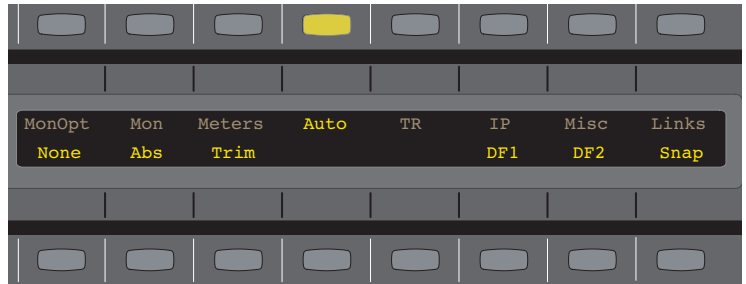

Selecting None disables external MIDI control, giving full control of the fader level to the desk faders.

Selecting Abs disables the physical faders, giving full control of the fader level from received MIDI volume data.

Selecting Trim enables simultaneous control from both the MIDI data and the physical faders, allowing the received MIDI volume messages to trim the channel level set by the console faders in Analogue Focus mode. The last three soft keys in the Auto menu are functions of the A-FADA mode, where the DAW is controlled by audio tracks within the DAW.

The Automation status of each channel (**None**, **Abs** or **Trim**) will be stored within each TR snapshot.

*These soft keys do not remain lit once they are released. Their status is indicated by the **AUTO** LEDs in the channel meters. See Page 46 for more details.*

Selecting DF1 enables the A-FADA method of automation. **DF1** stands for '**DAW Follow 1**'. The analogue channel faders now follow any volume automation written on the first 16 audio tracks in the DAW you have set up on Layer 1.

Selecting DF2 enables the A-FADA method of automation. **DF2** stands for '**DAW Follow 2**'. The analogue channel faders now follow any volume automation written on the first 16 audio tracks in the DAW you have set up on Layer 2.

Selecting Snap restores the last known analogue channel fader positions you had set before one of the **DF** buttons was pressed and writes those positions into the DAW.

TR Soft Keys

The TR soft keys allow Matrix's Total Recall functions to be controlled from the console (TR is described on page 73):

Enable enables TR for restoring snapshots.

TakeTR takes a TR snapshot.

SetSel sets a TR snapshot to any channels selected using the upper **SEL** key.

SetAll sets a TR to the whole console.

Cur: displays the TR number which is currently selected in the **Total Recall** tab of the Matrix Remote.

<< selects the previous TR snapshot

>> selects the next TR snapshot

Tip - Don't forget to press the ENABLE button after using the << and >> buttons to show the TR snapshot.

IP Soft Keys

The IP soft keys allow you to switch the console's IP address between Fixed and DHCP.

The IP address information is shown after the DHCP button. By default, Matrix uses a fixed IP address of 192.168.1.2. with the subnet mask set to 255.255.255.0.

See Page 5 for a description of how to change the fixed IP address.

See Page 4 for details of configuring the console's Ethernet connectivity.

Misc Soft Keys

The Misc soft keys cover miscellaneous Matrix settings:

InpCut configures the channel **CUT** buttons. By default, pressing the channel **CUT** button mutes the channel output, leaving any pre-fader feeds from the channel unaffected. Pressing InpCut causes the **CUT** buttons to mute the channel after the input, muting any feeds from the channel that are not sourced from the **INPUT**.

OptDAC switches between the two digital inputs. By default, the AES (XLR) input is selected. Pressing the OptDAC button selects the S/PDIF input, and the button lights to indicate that this input has been selected.

Fader Options:

Mst+10 rescales the master fader. By default, the master fader reaches 0dB at the top, following the scaling labelled on the left of the fader. Pressing Mst+10 switches the meter's scaling to reach +10dB at the top, following the labelling on the right of the fader.

0dB and Off move the analogue faders on any channels selected using the upper **SEL** key to 0dB and $-\infty$ respectively.

ShowdB toggles display of the analogue fader levels in the scribble strips when in analogue focus mode.

Meter Signal Scale Option:

The default scale for all of the LED meters is meters is 0dBfs corresponds to an analogue level of +24dBu. The +18dB button provides an alternative scaling of +18dBu.

USB Keyboard Identifier:

The KeybID key is used to identify the nationality of keyboard being emulated by the Matrix USB soft keys. See Page 4 for details.

Links Soft Keys

Creating Links

V2 software adds a powerful fader linking feature. Fader linking allows you to link 2 or more faders together in one link group. Once faders are linked, you only have to move one of them and all other faders in that link will follow. This may be useful for work with stereo instruments or for easy tweaking of the overall balance of a drum kit.

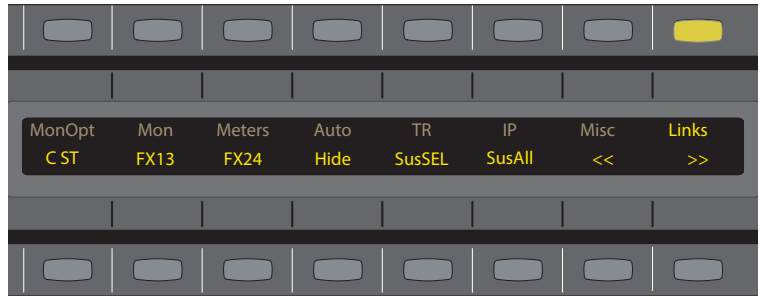

Upon pressing the **LINKS** button, the mode display on Matrix will change to show the letter '**LI**'. This indicates you are in the first link group. Pressing the upper **SEL** key on the desired channels will put faders in to that link group. For instance, press the upper **SEL** key on Channel 1 and then press the upper **SEL** key on Channel 2. Both faders are now linked.

In order to link faders 3 and 4 together, you need to move to the next link group. To do this, use the **>>** key in the **LINKS** menu. The **MODE** display will now read '**L2**' to indicate you are setting up the second link group. Once again, simply press the upper **SEL** key on the appropriate channels (3&4) to link them together.

There are eight link groups available in total. The **<<** and **>>** arrows will move you between the groups.

Link Soft Keys

The **LINKS** menu offers a range of useful functions for linking.

Pressing the **C St** button so that it lights will link the on/off function of the Stereo Cue knob. This setting is specific to the currently selected link group.

Pressing the **Fx13** button so that it lights will link the on/off push function for the FX 1/3 knob. This setting is specific to the currently selected link group.

Pressing the **Fx24** button so that it lights will link the on/off push function for the FX 2/4 knob. This setting is specific to the currently selected link group.

The **Hide** function is useful for when you don't want to see the slight 'lag' of the faders in a link. Pressing **Hide** will throw all faders in the current link group down to the bottom of the fader travel, apart from the first one in the link. The first fader in the link will still be controlling all the other linked faders but those faders are hidden. Usefully, the scribble strip display (when in Analogue Focus) will still display the dBs values of all hidden faders. This setting is specific to the currently selected link group.

SusSel will suspend the currently selected link group.

SusAll will suspend all links across all link groups.

<< selects the previous link group.

>> selects the next link group.

Tip - If you need to re-adjust the relative balance of a group of linked faders, simply ensure you are touching one of the faders in that link and move the faders that need re-adjusting. This allows you to achieve the same thing as turning 'SusSel' on and off but faster.

Matrix Automation

There are three methods of analogue automation on Matrix; the latest being Delta control, the legacy implementations being the MIDI method, and the AFADA method. All three are detailed in the following section.

The Delta Control Method

(Requires V3 software and upwards)

Delta Control is a unique analogue automation system that allows you to write, store, and edit your analogue fader levels and switches from a plugin in your DAW. Having all analogue automation stored within your DAW as plugin automation allows for easy recall and editing of mixes, similar to the 'in-the-box' workflow. This operates alongside a range of options within the Matrix 'Auto' menu, that allow you to mix in a traditional hands-on workflow.

To work with Delta control, simply insert a Delta plugin anywhere in your DAW, assign it to a channel on Matrix, enable automation on the console, and then write moves like you would with any other plugin.

Delta Plugins

For Matrix there are two workflow options - using either a Single-Fader plugin or a 16-Fader plugin.

Benefits of the Single-Fader Delta Control Plugin

An individual plugin for an individual channel/bus

- ▶ The ability to enable/disable automation modes on individual channels of Matrix (when you write to one channel, the other channel can be in read/off mode).
- ▶ If only automating a small number of channels, the Single-Fader Delta plugin offers the neatest solution. Simply insert plugins as and when automation is required on a particular channel.
- ▶ Easy cross-compatibility between all Delta console sessions including Duality, AWS, and Sigma.
- ▶ Ability to view relevant channel waveform against automation lane data.

Benefits of the 16-Fader Delta Control Matrix Plugin

One plugin containing all 16 channels of automation parameters

- ▶ Quicker set up of multiple channel automaton as all parameters are contained within the one plugin instance.
- ▶ Compatible with Logic Pro.
- ▶ Easy to view all channels of automation at once.

The Single-Fader' Delta Plugin GUI

The SSL Delta Control Plugin GUI

- 1 **Console Type, Console Object (Channel or Bus), & Console Object Number.** Ctrl Click to enable/disable the Auto increment feature. *Object number is greyed out when active.*
- 2 **Fader Status** - Indicates write status of fader on the console.
- 3 **Fader** - Click on Fader and drag to change level. Double click to set to 0dB. Fader knob will change to gold if Trim has been enabled.
- 4 **Fader Levels** for Abs and Trim in dB.
- 5 **Channel Switches** - Indicates current switch state. Click on the switch to toggle console state and write automation.



The 16-Fader Delta Plugin GUI

The SSL Delta Control Matrix Plugin GUI



- 1 **Channel Switches** - Indicates current switch state. Click on the switch to toggle console state, and write automation.
- 2 **Channel Label** - names as displayed on the console. These displays will illuminate when a parameter is automated and switch to show dB values when faders are moved.
- 3 **Cut Switch** - Indicates current switch state. Click on the switch to toggle console state, and write automation.
- 4 **Fader** - Click on Fader and drag to change level. Double click to set to 0dB. Fader knob will change to gold if Trim has been enabled.
- 5 **Fader Levels** for Abs and Trim in dB.

Setting up a Mix

Once you have installed all the relevant software as detailed in Chapter 1, the next step is to configure your DAW settings. The following section details suggested settings for your DAW before working with Delta Control.

Pro Tools Settings

Before mixing with the plugin, the following options should be enabled in the *Pro Tools Setup > Preferences > Mixing* menu.

- 1 **Plugin Controls Default to Auto-enabled** – Otherwise the parameters will need to be manually enabled for automation from each individual plugin window either manually or using the Command-Option-Ctrl-click (MAC) or Ctrl-Alt-Start-click (PC) short-cut.
- 2 **Latching Behaviour for Switch Controls in Touch** – This ensures that console switch automation is recorded correctly when the track automation mode is set to Touch.
- 3 **Set the SSL Delta Control plugin as a favourite** - Command-click (Mac) or Control-click (PC) the Insert Selector and then selecting the SSL plugin from the Other category. It will then appear at the top of the Insert Selector pop-up menu for fast access.

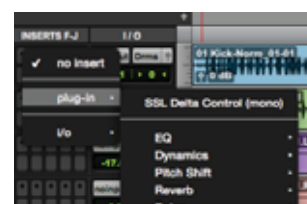
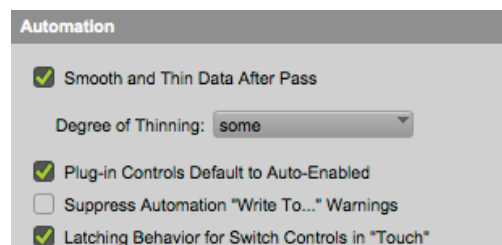

Logic pro Settings

Before mixing with the plugin, the following options should be enabled in the *Logic Pro X > Preferences > Automation* menu.

Please note: to access the 'Automation' menu, you may need to go to the *Logic Pro X > Preferences > Advanced Tools* menu, and click the tick box for 'Show Advanced Tools'.

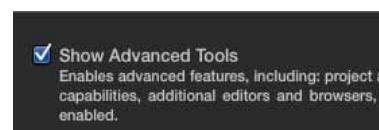

- 1 **Write automation for...** - The 'Plugin' option should be ticked. This enables all parameters of the delta plugin for automation.
- 2 If using Logic 10.1 or over, go to *Logic Pro X > Preferences > Plug-in Manager*. Locate the SSL Delta Control plugin under 'Manufacturers' in the left hand pane. Drag and drop the SSL Delta Control plugin on the 'Top Level' item in the left hand pane. When you go to enter an Audio FX unit on a track, the plugin will appear at the top of the list for quicker entry.



Nuendo / Cubase Settings

Before mixing with the plugin, the following options should be enabled in the *Devices > Plugin Manager*

- 1 Click on the downward arrow in the top right corner of this window, go to *New Collection > Copy Current Collection* and name this new collection (eg. 'Plugin Favourites'). Find the SSL Delta Control plugin from the list of plugins on the left of this window, and drag it to the top of the 'New Collection list' on the right. Close this window, and click on a channel insert. Click on the dropdown arrow in the right hand corner of the list and ensure the new collection is selected (eg. 'Plugin Favourites'). The SSL Delta Control will appear at the top of the directory, and is therefore quicker to add to your session (particularly when using the Single-Fader plugin).

Ableton Live Settings

Before mixing with the plugin, the following options should be enabled for Ableton Live. Set the SSL Delta Control plugin as a 'favourite' by opening your VST3 directory:

Mac: *Library/Audio/plugins/VST3/*

Windows: *C:\Program Files\Steinberg\Vstplugins*

- 1 Create a New Folder next to the VST folder, and name it (eg. 'My Favourite VST's'). Command-alt drag (Mac) or alt-drag (PC) the SSL Delta Control plugin from the VST folder to this new folder. This will create an alias/shortcut for the SSL Delta Control plugin.
- 2 Reload Ableton Live and go to the *Live menu > Preferences > File/ Folder*. Next to 'VST plugin Custom Folder' click the 'Browse' option and double-click on the newly created 'My Favourite VST's' folder containing the alias.
- 3 Set 'Use VST Plugin Custom Folder' to 'On'. When inserting a plugin on a track, the 'Favourite Plugins' folder will appear in the Ableton plugins directory; therefore, the SSL Delta Control plugin will be quicker to add to your session (particularly when using the Single-Fader plugin).

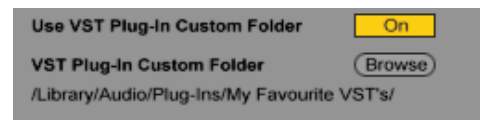
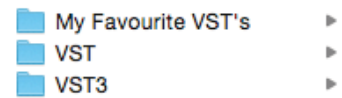

DAW Session Setup

Once your DAW settings have been configured, the next step is to add the Delta plugins to your session. Open a session in your DAW software, and follow the steps outlined below.

There are two Delta Control workflow options; the Single-Fader plugin workflow, and the 16-Fader plugin workflow. The benefits of each workflow are outline on page 50.

Please note that due to the control parameters set by Logic Pro, Logic Pro users can only use the 16-Fader plugin workflow.

Single-Fader Plugin Workflow

This example describes setting up all 16 channels of Matrix for automation using the Single-Fader plugin - it is possible to add individual plugins and assign them to individual Matrix channels during the mixing process.

- 1 Insert 16 Single-Fader SSL Delta Control plugins onto any tracks.
- 2 Open the SSL Delta Control plugin that is going to be assigned to channel 1. Set the Console Type to *MATRIX*, Console Object to *CHAN*, and Console Object Number to *1*. Ctrl-click on the Console Object Number (*1*) to use the auto-increment feature – the number will now be greyed out. This feature can be disabled by a second Ctrl-click on the Console Object Number.



Caution: Do not alt-drag (copy) Delta plugins or duplicate tracks that already have Delta plugins that have been assigned to Matrix channels as this will cause Delta Control to stop working. Copying plugins and duplicating tracks with Delta plugins inserted must only be done if the plugins are not yet assigned to a channel on the console.

- 3 As the auto-increment feature is enabled, clicking on each SSL Delta Control plugin sequentially will assign each plugin to the next logical Matrix channel available. Matrix channel names will be pulled from the Matrix console to the corresponding SSL Delta Control plugin.

Please Note: It is recommended that the SSL Delta Control plugins are added to channels with the corresponding output to Matrix (for example, the Delta Control plugin that controls channel 4 of Matrix added to the insert of the Pro Tools audio track routed to output 4 on your audio interface). This is useful for writing automation over the waveform of the audio track.

- 4 Make sure that your track automation status is set to *Touch*. Both touch and latching style automation can be achieved using the 'SNAP' option in the console auto menu (more details in the following section).

Note for Ableton Live users: As Ableton Live only has a 'latching' style automation, the **SNAP** option in the console auto menu will not function. To achieve a 'touch' style automation mode, after recording an automation move take the console out of record mode using the Matrix' 'record' transport switch.

Note for Logic Pro users: Due to the functionality of switch parameter automation in Logic Pro, we advise automating Cut, Cue, and FX switches using the *Latch plugin* automation status in Logic Pro. When writing fader automation, setting the plugin automation status to *Touch* and using the **SNAP** option in the console **AUTO** menu to toggle touch and latching style automation will function as expected.

16-Fader Plugin Workflow

This example describes setting up all 16 channels of Matrix for automation using the 16-Fader SSL Delta Control Matrix plugin.

- 1 Insert the SSL Delta Control Matrix plugin onto any track in the DAW session
- 2 Make sure that your track automation status is set to *Touch*. Both touching and latching style automation can be achieved using the 'SNAP' option in the console auto menu (more details in the following section).
- 3 Once the console has been enabled for automation (please see following section 'Enabling the console for automation'), click on the 'Connect to Matrix' dropdown menu in the left corner of the plugin GUI, and click on 'Connect'. The text will disappear once connected to the console.



Note for Ableton Live users: As Ableton Live only has a 'latching' style automation, the **SNAP** option in the console auto menu will not function. To achieve a 'touch' style automation mode, after recording an automation move take the console out of record mode using the Matrix' 'record' transport switch.

Note for Logic Pro users: Due to the functionality of switch parameter automation in Logic Pro, we advise automating Cut, Cue, and FX switches using the *Latch plugin* automation status in Logic Pro. When writing fader automation, setting the plugin automation status to *Touch* and using the **SNAP** option in the console **AUTO** menu to toggle touch and latching style automation will function as expected.

Automating the Mix Bus Level

Whether you are using the Single-Fader plugin workflow or I6-Fader plugin workflow, the process for automating the Matrix Mix bus is the same.

- 1 Add another Single-Fader SSL Delta Control plugin to your session on any track (for example, a bus or master fader channel).
- 2 Set the Console Type to *MATRIX*, Console Object to *BUS*, and ensure the Console Object Number is 'M' (for 'Mix' bus).



- 3 Make sure that your track automation status is set to either Touch or latch for automation.

Please Note: In Logic Pro, the AU Single-Fader plugin will only appear as a bus fader, due to the control parameters set by Logic software. For channel automation in Logic pro, use the I6-Fader SSL Delta Control Matrix Plugin.

Enabling the console for automation

Once the Delta plugins have been added to your DAW session, the final step before starting your analogue mix is to enable automation on the console. Within *SSL MENU > AUTO* on the Matrix console, you will see two new options for engaging automation; *ENABLE* and *NEW MIX*.

- When engaging automation for the first time during a mix, pressing *NEW MIX*, followed by *ENABLE* will 'push' all fader / switch positions from the console to the Delta plugin(s).
- When returning to a mix / re-engaging automation, pressing just *ENABLE* will 'pull' all fader / switch positions from the Delta plugin(s) to the console.
- If using the I6-Fader SSL Delta Matrix plugin, you will need to click on the 'Connect to Matrix' dropdown menu in the left corner of the plugin GUI, and click on 'Connect' once the console has been enabled.

After you have enabled the console for automation, all channel names will appear in the Delta plugin(s). Simply press play on your workstation, and you can start automating your analogue mix!

To disengage automation mode on the console, press the *ENABLE switch* again so that it is no longer illuminated.

Please Note: Once Delta Control is enabled, the right-channel bargraphs on the meter bridge may display the current fader position. This can be toggled on/off from the 'Show Faders' option under the 'Delta' tab in the Matrix Remote.

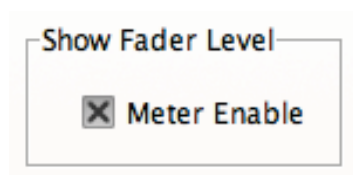

Delta Control and Total Recall

When enabling Total Recall to recall a snapshot, we advise disabling Delta Control automation on the console. This can be done from the *SSL MENU > AUTO* on the Matrix console by ensuring the *ENABLE* key is not illuminated.

Console Automation Menu

Once you have enabled the Matrix console for automation, you can start automating your mix. After the **ENABLE** button is illuminated, a series of automation options will appear in the **AUTO** menu on the console - this section will detail what these options do.



SNAP

Snap mode toggles the console between a 'touch' and 'latch' style automation state.

- ▶ When snap is **ON**, the console will act in a 'touch' automation style - releasing the faders whilst writing automation will move them back to the original position stored in the plugin automation lane. Glide / release times are set from the DAW automation system.
- ▶ When snap is **OFF**, the console will act in a 'latch' automation style without having to change the DAW automation style - even if the faders are released, they will continue to write automation (as far as the DAW is concerned, the Matrix faders are still being touched).

Please Note: With snap mode **OFF**, touching a fader with the DAW in Stop will also pre-arm the track, which will drop into write on entering Play.

Note for Ableton Live users: As Ableton Live only has a 'latching' style automation, the **SNAP** option in the console auto menu will not function. To achieve a 'touch' style automation mode, after recording an automation move take the console out of record mode using the Matrix 'record' transport switch.

Note for Logic Pro users: Due to the functionality of switch parameter automation in Logic Pro, we advise automating Cut, Cue, and FX switches using the **Latch plugin** automation status in Logic Pro. When writing fader automation, setting the plugin automation status to **Touch** and using the **SNAP** option in the console **AUTO** menu to toggle touch and latching style automation will function as expected.

REPLAY

The Replay switch takes all channels out of 'write' mode. Automation write status is indicated by the red LED on the meter bridge. If the left LED is flashing red, the channel is in write mode - in this mode, if the DAW is in Play and the DAW track with the Delta plugin is in an automation write mode such as 'touch', automation will be written to the Delta plugin. If the LED is unlit, the channel has dropped out of write mode, and will revert to a 'Read' automation style.

- When writing automation, pressing the replay switch will drop all channels and master fader out of write mode (similar to 'All Replay' on AWS and Duality).
- To drop individual channels in and out of write mode, when in 'analogue focus' press the **AUTO-SET** button (found amongst the **SEL KEY** DAW controls) and the lower **SEL** keys (usually used for selecting DAW tracks) will now toggle fader automation status for the analogue channels.



REVISE & JOIN

Revise and Join are popular options from the original SSL 4000 console automation computer, that allow you to mix by song section. If any channels are in write when DAW playback is stopped, the **JOIN** and **REVISE** keys will illuminate. Once illuminated, each key has the following functionality:

- **REVISE** is a snapshot of the fader write status at the Stop position; pressing the **REVISE** key will return all the channels that were in write at the stop point back into write.
- **JOIN** is a snapshot of the fader levels and write status at the stop position; pressing the **JOIN** key will return all channels that were in write at the stop point back into write, but at the levels that they were at when the playback was stopped.

Tip: JOIN offers a very comfortable approach to building a mix pass by allowing the engineer to refine the balance of each section of a track in real time (eg. finding a static balance on the faders for Verse 1), and then return to the start of that section and 'fire in' that balance with a single JOIN key press.

REVISE and **JOIN** can be used when the DAW is either in Play or Stop to return channels into Write or to 'punch' the 'captured' levels back into the mix. If **REVISE** and **JOIN** are used in Stop, then automation starts writing when the DAW playback is started.

Please Note: The 'revise' and 'join' memories remain active until used. If required, they can be cleared by the use of the 'replay' key, and are automatically updated if faders are manually dropped into write whilst DAW playback is active.

For correct operation of **JOIN** & **REVISE**, the DAW with the Delta Control Plugin inserted must be set to be controlled by DAW Layer 1 of Matrix (see page 12).

TRIM & T-ALL

Trim automation is an additional layer of level automation that will add or subtract from the automation values stored in the 'absolute' pass. For example, if an engineer rides the vocal level over a section in 'absolute' (trim not engaged) mode, and then later decides to lower the overall vocal level for that section by 2dB, using the Trim automation mode will allow them to 'trim' that automation down by 2dB without losing the original automation move riding the vocal. Alternatively, this can now be done by manually selecting sections of automation in the Delta Control plugin automation lane, and moving them up or down with the mouse like any other plugin.

Trim mode for a channel is indicated by the green LED on the meter bridge. Also, the fader caps in the SSL Delta Control plugins will turn gold when in trim mode.

- Pressing the **T-ALL** button will switch all channels and master fader from 'absolute' to 'trim' mode.
- To drop individual channels into Trim mode, when in 'analogue focus' press the **TRIM** key under the **SSL MENU > AUTO** menu, and then the **AUTO SET** button (found amongst the **SEL KEY** DAW controls); the lower **SEL** keys (usually used for selecting DAW tracks) will now toggle Trim status for the analogue channels.

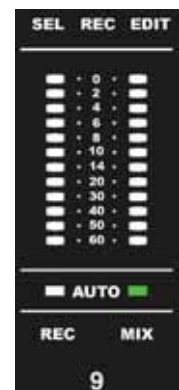

M-OFF

Some engineers prefer to hear moves rather than see them - for these engineers, the ***M-OFF*** (Motors Off) function is the perfect solution.

- Enabling ***M-OFF*** disengages the fader motors, with the high-resolution digitally controlled attenuators (DCA's) still actively changing the channel levels according to the automation stored in the Delta Control plugin; you will hear the changes, but not see them on the console.

In normal operation, the faders will not affect channel level while ***M-OFF*** is engaged. However, some engineers like to grab a fader and drop into write mode when ***M-OFF*** is engaged - to do this, open the Matrix Remote application, go to the Delta tab, and tick the ***Motors Off Mode > Touch Enable*** option.

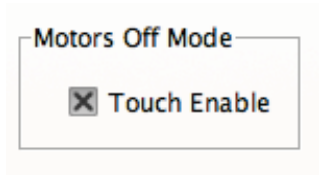

Please Note: The right-channel level bargraph continues to show the current fader position according to the automation stored in the Delta Control plugin. This can be toggled on/off from the ***Show Faders*** option under the Delta tab in the Matrix Remote (see page 82)

The MIDI Fader Method

Note that the following description of the MIDI automation system presumes some knowledge of the Matrix Transport and Utility buttons, described in Chapter 5.

Although Matrix does not include a stand-alone analogue automation system, the 16 analogue channels can be remote controlled via MIDI Volume messages (CC7). Creating 16 additional MIDI tracks in the current DAW project integrates full level control of the 16 analogue channels receiving the stereo stems and mono mix elements that Matrix is summing for the final mix master. All the DAW automation tools can then be used to create the level rides that are required to create the final mix in the analogue domain. The faders of these MIDI tracks can be used to input level data in real time and control the analogue channels.

The MIDI volume data received from the workstation can control the Matrix channel strips in two modes, accessed via the SSL soft keys (see Page 44):

- In absolute (Abs) mode the volume data replaces the levels set by the Matrix faders in Analogue Focus mode;
- In Trim mode the MIDI data adds or subtracts from the level set by the desk faders in Analogue Focus mode in a similar fashion to a VCA-style master fader;

*Tip: Pressing the **MF Focus** button while in Analogue Focus mode (described on Page 84) will allow you to trim one channel of automation via the master fader, while retaining access to the channel faders.*

- A third mode, None, mode returns full level control to the Matrix faders.

This unique capability allows final mix rides to be run post the analogue signal processing inserted in the channels receiving the DAW outputs. As all automation data is part of the workstation project and the associated DAW timeline, it can easily be set to move with edits in the timeline, allowing automation to stay with its associated audio even if the session timeline is completely re-arranged.

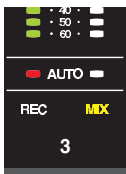

These automation modes are channel-specific. The automation mode soft keys affect whichever channels are currently selected using the upper **SEL** keys. Note that these soft keys only have momentary indication: once you have selected a channel's automation mode, the soft keys do not remain lit. The mode of each channel is continuously displayed in the red and green **AUTO** LEDs in the channel meters: in None mode neither LED is lit, in Abs mode the red LED is lit, and in Trim mode the green LED is lit.

The automation is recorded as MIDI Volume changes on 16 DAW MIDI tracks. Which should be configured as follows:

- The MIDI track outputs should be assigned to ipMIDI port 9, channels 1-16 (with MIDI Channel 1 corresponding to Matrix Channel 1, MIDI Channel 2 corresponding to Matrix Channel 2 etc.).
- They will need to be in an appropriate automation write mode (such as Touch in Pro Tools).
- It will be helpful to have their track views showing volume data.
- You may want to name them appropriately, for example: **Auto 1** to **Auto 16**.

With the console in DAW Focus mode, use the **BANK** and **CHANNEL** keys (see Page 90) to scroll the Matrix control surface to the 16 MIDI tracks. If the 16 channels are contiguous they will be able to all be on the Matrix control surface simultaneously, in the channel corresponding to the analogue signal they are affecting.

Tip: create a view (Logic) or memory key (Pro Tools) to select a layout containing only the 16 MIDI faders used to control Matrix.



The above screenshot is an example of how to setup Pro Tools to run the Matrix automation system. You should create 16 midi tracks to control the 16 analogue channels of Matrix. The outputs of each midi track are set to ipMIDI port 9. The first midi track is set to ipMIDI port 9 channel 1, the second midi track is set to port 9 channel 2 and so on.

When the DAW is in Play, any fader movements on the console channels will be recorded in the MIDI tracks. The consequent level changes will then be replicated when the automated tracks are replayed.

Note that for the automation to be replayed, the 16 MIDI channels must be in an automation mode that outputs automation (such as Read in Pro Tools or Logic).

You will notice that the MIDI automation affects the analogue signals in the Matrix channels without moving the channel faders.

Note that, while in DAW Focus mode, you cannot normally view the channel signal level in the meters. The Meters menu the SSL soft key menu provides the option of locking the meters to the analogue channel levels regardless of the current desk Focus mode, enabling the analogue channel signal level to be viewed while writing automation. See Page 44 for more details.

The A-FADA Method

A-FADA (Analogue Fader Accesses DAW Automation) is an innovative approach to analogue console automation, utilising the automation system of a DAW to control the analogue channel levels.

A-FADA links the DAW fader and mute data to the console's channel level and cut functions, allowing all the workstation automation editing tools to be used on a mix that is actually taking place in the analogue domain, providing the workflow advantages of 'in the box' mixing whilst retaining a full analogue process and mix path.

Operationally, A-FADA is identical to running a standard DAW mix from a hardware control surface. With this in mind, the descriptions below should provide enough information to get you going.

Setting up A-FADA

As A-FADA works by sending out volume information over HUI/MCU protocols, it is presumed that your Matrix is already working a control surface, with the relevant HUI/Mackie Controller setup in your DAW.

In your DAW, create 16 new blank audio tracks which will be used to control the analogue channel faders on Matrix. Make sure that these 16 audio tracks are positioned as the first 16 tracks of the session. Any volume automation data or fader movements on these 16 tracks will control the analogue channels of Matrix.

Your existing tracks with audio recorded to them should be routed out of different outputs on your audio interface and into Matrix via the analogue channel inputs as normal.

If you have existing DAW automation you wish to re-use, copy it from the audio tracks and paste it to the blank tracks you have

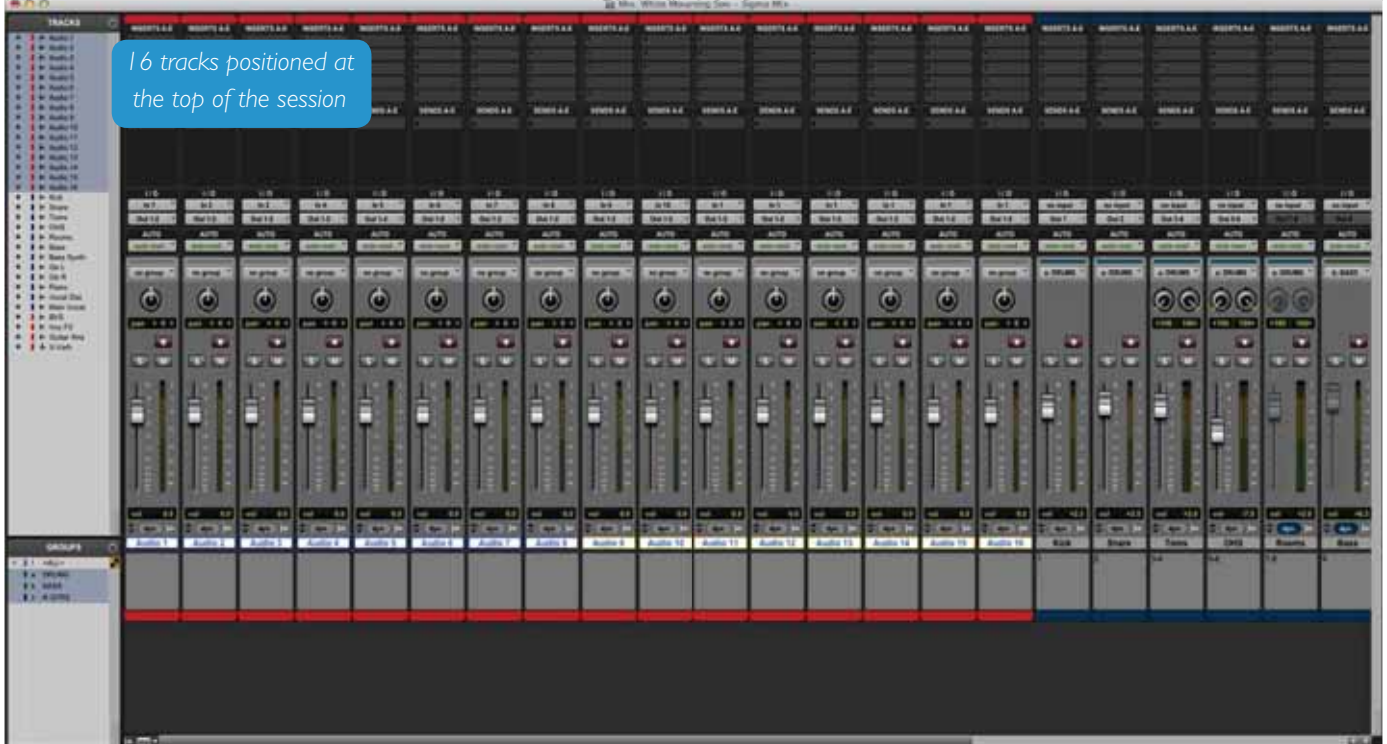

just created. You will then need to either disable or delete the automation from the original tracks.

If the automation is deleted rather than disabled, micro-automation (such as the removal of undesirable transients) can be performed on the original audio tracks within the DAW using a mouse or trackball

Now you are ready to engage A-FADA. Press the **SSL** button on the Matrix and then press the **Auto** button. This example presumes you want your DAW on DAW layer 1 to control Matrix's channels. Simply press the **DF1** button and your DAW faders now control Matrix's analogue gains.

If you wish to use the DAW you have configured on DAW layer 2, then press the **DF2** button instead.

Note: These 16 audio tracks must be positioned as the first 16 in the session, as the HUI/MCU protocols dictate this.

Tip: You probably want to rename these Audio Tracks to have meaningful names such as 'KICK' instead of 'Audio 1'.

The Snap function

The snap function fires a snapshot of the console analogue fader positions, automatically stored when A-FADA mode is enabled (when you press the **DF** button). When A-FADA mode is enabled, the console faders will move to match the current DAW fader positions. Pressing the **Snap** switch will move the faders back to the previously stored positions, allowing the analogue balance to be restored and written into the DAW automation.

Operating A-FADA

Once A-FADA mode has been enabled, the console faders will control the corresponding DAW faders, and the fader position signal from the DAW will control the console fader positions and analogue gain, regardless of the selected Focus mode.

In Analogue Focus the channel cut switches control the analogue cuts directly, while in DAW Focus they are routed via the DAW and will be recorded as mute automation. Analogue Focus mode allows channels to be muted as far as monitoring the mix is concerned, without writing mute automation or needing to change automation modes.

The console solo switches are connected to the analogue signal path in both Focus modes.

In order to lock console channels to the same DAW track (and thus its automation), Channel/Bank scrolling is disabled in A-FADA mode.

Extra Setup Information for using A-FADA with Logic

You need to ensure that Logic's Control Surfaces Preferences are set correctly. Go to **Preferences > Control Surfaces**. Ensure that the options '**Touching Fader Selects Track**', '**Control surface follows track selection**' and '**Flash Mute and Solo buttons**' are all un-ticked.

It is also recommended to set the Logic Mixer to 'Arrange' view mode. This ensures that the first 16 'control tracks' always correspond to Matrix's 16 analogue channels. If using Instrument tracks with Multi Outputs, also ensure that the 'Link' button is disabled, to prevent Logic automatically switching back to 'All' view mode when you click on an instrument.

Logic Tip - Because A-FADA will 'lock out' the Channel/Bank keys, in Logic you can use 'Control Surface Grouping' to use another DAW layer as your control surface. For example, if you were using DAW 2 for A-FADA, you could use DAW 3 for general control surface purposes. Simply add another Mackie Control and Extender for this layer and then drag them beneath the existing ones in the setup page in Logic.

Chapter 4 - The Matrix Remote

In this chapter, we will examine how the Matrix configuration and session information can be controlled and managed in the Matrix Remote.

For details of installing the Matrix Remote software, see Chapter 1.

Introduction to the Matrix Remote

There are six tabs in the Remote window:

- **Projects** is where you select the current Project and Title, and where you administrate the data related to specific Projects and Titles, including the data held within the **Total Recall**, **Channels** and **Insert Matrix** tabs.
- **Total Recall** manages the storing and recalling of console settings.
- **Channels** allows you to label the console's analogue channels.
- **Insert Matrix** controls the routing of channel inserts.
- **DAW** configures the protocol used to link Matrix with your DAW, along with its soft key assignments.
- **Delta** allows you to switch between Delta Control and legacy automation modes, and configure Delta Control automation settings.
- **About** displays the Matrix console and Remote software versions currently installed, and contains useful short cuts to the SSL website for product support, FAQs, registration and downloads.

This chapter deals with those tabs which are concerned with session-specific data, namely the **Projects**, **Total Recall**, **Channels**, **Insert Matrix** and **Delta** tabs. The **DAW** tab is related to the basic configuration of Matrix rather than to specific sessions, and is examined in Chapter 5. The **About** tab requires no further explanation.

Note that the Matrix configuration data controlled from the Remote is stored on the SD card in the back of the Matrix console (see Page 2), not on the computer hosting the Remote.

The Projects Tab



The **Projects** tab is the left-most tab in the Matrix Remote:



There are three functions performed within the **Projects** tab. Firstly, it is where you create and manage all your Matrix Projects and Titles. Secondly, it is where you select the song Title which is loaded into the Remote and which is referred to in the **Total Recall**, **Channels** and **Insert Matrix** tabs (the 'Current Title'). Thirdly, it is where you store session notes.

In the Matrix Remote, a 'Project' is simply a folder of recordings which are grouped together on whichever basis you choose, and a 'Title' is a specific recording within that Project. For example, Titles might refer to different tracks within an album, and a Project might refer to the album as a whole. All settings created within the **Total Recall**, **Channels** and **Insert Matrix** tabs are specific to their Title and therefore different Titles within a Project can have completely different settings.

Navigating the Projects List

Folders can be listed by order of creation or in alphabetical order. Double-clicking on a folder expands it to reveal the sub-folders within it, as does clicking on the  sign in front of the folder. Similarly, double-clicking on an expanded folder collapses it again, as does clicking on the  sign. The folder architecture is as follows:

- The main **Projects** folder contains the folders for all the Projects;
- The individual Project folders contain all their Title folders;
- The Title folders contain (along with the unseen channel name file) the **Insert Matrix** and **Total Recall** folders.
- The **Insert Matrix** folder contains two files: **Matrix data** (the routing matrix you have created) and the **Insert names** (the insert names you have created) (see Page 69). The **Total Recall** folder contains all your TR snapshots (see Page 77):

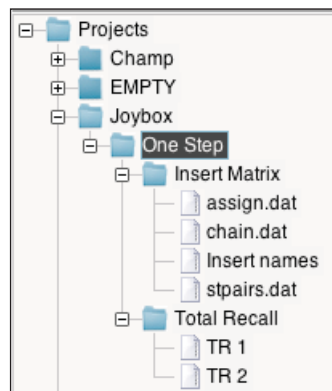

Although the files named 'assign.dat', 'chain.dat', 'stpairs.dat' are visible, they are for internal use only and should not be modified.

Title folders can be moved into other Project folders by dragging them onto the name of the Project to which you wish to move them. Press **OK** in the **Confirm Copy** pop-up which appears and a copy of the Title will appear in the new folder. **Total Recall** files can be dragged and dropped into the **Total Recall** folders of other Titles, in which case they are automatically renamed '**TR n**' where '**n**' is the lowest unused TR number in the **Total Recall** folder.

Managing Projects

Creating a Project

To create a new Project, simply press the '**New Project**' button in the bottom left-hand corner of the window. The following window will appear asking to name the Project and the first Title.



Backing Up a Project

To back up a Project or export it for use in another Matrix Remote, right-click (Mac: ctrl+click) on the Project you wish to back up and select **Backup Project**. In the pop-up which appears, edit the name and destination of the file if necessary, and press **Save**. Your Project will be exported as a ZIP file.

Restoring a Project

To restore a Project from back-up or import a Project created in another Matrix Remote, right-click (Mac: ctrl+click) on the main **Projects** folder and select **Restore Project**. In the pop-up which appears, locate the Project zip file you wish to restore and press **Open**. The restored Project will appear in the main Projects folder, with its filename appended with '**(Restored)**' to distinguish it from any parent Project of the same name. You can now rename the Project as described below.

Renaming a Project

To name a Project, select the Project which you wish to rename, and make one of its Titles the Current Title. You can now edit Project name and other details in the **Notes** area in the right hand side of the window. Once you have finished, press **Save Notes** (located below the **Title** area) to save your changes.

Pressing **Undo** will bring up a pop-up warning that you will lose unsaved changes if you continue. Click **Yes** to revert the text to its last saved state.

To name a Project without making it current, select the appropriate Project folder and press the **Rename** button at the bottom of the window. Alternatively, right click (Mac: ctrl+click) on the folder and select **Rename** from the drop-down menu. This will produce the **New Name** pop-up. Type the Project name, and click **OK**.

Deleting a Project

To delete a Project, right click (Mac: ctrl+click) on the folder and select **Delete** from the drop-down menu. Click OK in the **Confirm Delete** pop-up to delete the Project.

Please be aware that this action cannot be undone.

Managing Titles

Creating a Title

To create a new Title, simply press the **New Title** button and a new Title pop-up window will appear. This will create a new Title in the currently selected Project.

To create a new Title in a different Project, first open another Title in the desired Project using **Open Title**, then click **New Title**.

The **New Title** pop-up Window will prompt you for the following:

Title Name - Name your New Title

Channel Names - Allows you to choose between the following:



- > **Last Used** - Imports the same analogue channel names as used in the currently selected Title.
- > **Default** - Names the channels in consecutive order '**Chan1**', '**Chan2**' etc.
- > **List of Presets** - Underneath the options for **Last Used** and **Default**, you will see a list of any saved Channel Name presets you have created using the **Save Channel Names as Preset** option in the Channels page of the browser. See later in this chapter for more information on this.

Insert Matrix - Allows you to choose between the following:



- > **Last Used** - Imports the same Insert Matrix as the currently selected Title. The devices will be inserted in the same positions.
- > **Default** - Returns all devices to be available in the right-hand list.
- > **List of Presets** - Underneath the options for **Last Used** and **Default**, you will see a list of any saved Insert Matrix presets you have created using the **Save Insert Matrix as Preset** option in the Insert Matrix page of the browser. See later in this Chapter for more information on this.

Opening a Current Title

When Matrix is turned on, it will automatically open the last loaded Title. To load a different Title onto Matrix (and therefore into the rest of the Remote), highlight the required Title folder and press the **Open Title** button located at the bottom of the screen. Alternatively, right-click (Mac: ctrl+click) on the Title folder and choose **Open Title** from the drop-down menu which appears.

The Current Title and its Project is displayed in the right hand side of the **Projects** tab, as well as in the top and bottom of the Remote. It is also displayed in the soft key area of the console, when the SSL set is selected without any menus active.

Once the Title is loaded, the Matrix console will assume the channel names and insert routing within the Title. You can now also edit session notes, and recall the Title's Total Recall snapshots, as described in the rest of this chapter.

Note: Loading a song into the Remote does not automatically recall a Total Recall snapshot onto the Matrix control surface. See Page 71 for details of how to recall a snapshot.



Renaming a Title

To name a Title, select the Title which you wish to rename, and make it the Current Title. You can now edit Title name and other details in the **Notes** area in the right hand side of the window. Once you have finished, press **Save Notes** (located below the **Title** area) to save your changes.

Pressing **Undo** will bring up a pop-up warning that you will lose unsaved changes if you continue. Click **Yes** to revert the text to its last saved state.

Right click (Mac: ctrl+click) on the folder and select **Rename** from the drop-down menu. This will produce the **New Name** pop-up. Type the Title name, and click **OK**.

Duplicating and Copying a Title

To duplicate a Title, right-click (Mac: ctrl+click) on the Title folder and choose **Duplicate**. A duplicate of the Title, including the Title Notes (see next page), Insert matrix and Total Recall folders and Channel Names folder, will appear at the bottom of the same Project folder, with a bracketed number e.g. (1) appended to the Title Name indicating it is a duplicate. Subsequent duplicates will incrementally increase the bracketed number.

To copy a Title to a different Project simply drag the Title into the destination Project folder and click **OK** in the **Confirm Copy** pop-up. Alternatively, right-click (Mac: ctrl+click) on the Title folder and choose **Copy to clipboard**. Right-click on the destination Project folder and choose **Paste from clipboard**.

Deleting a Title

To delete a title, right-click (Mac: ctrl+click) on the Title folder and select **Delete** from the drop-down menu. Click **OK** in the **Confirm Delete pop-up** to delete the title.

Please be aware that this action cannot be undone.

Project and Title Notes

The **Notes** area on the right-hand side of the **Projects** tab allows you to record your own data related to a particular session, including personnel and any other information you might wish to link to that session. The top half records information related to the Project as a whole, whereas the bottom half records information related specifically to the Title currently loaded from that Project.

Any information typed here will be automatically saved as part of the Project and Title files. Renaming Projects and Titles overwrites any names you gave them using the **Rename** button. If you leave the Project and Title name boxes blank, the Remote will create its own names. The default naming system for a Project is simply '**Project n**' where '**n**' is the lowest number not used in this way. Similarly, Titles are simply named '**Title n**' where '**n**' is the lowest unused number within that Project folder.

When you have made your changes in the **Notes** area, press **Save Notes** to save your changes.

Pressing **Undo** will bring up a pop-up warning that you will lose unsaved changes if you continue. Click **Yes** to revert the text to its last saved state.

Track Sheets

A session track sheet, can be created and exported in the **Projects** tab. The track sheet includes the Project and Title Notes, Channel names and insert assignments, and a list of Insert Matrix devices and chains:

Press the **Track Sheet** button at the bottom of tab to create the track sheet. In the track sheet, pressing **OK** closes it and pressing **Save** brings up a dialogue box inviting you to define the name and location of the file. The file is exported as an .html file which can be opened and edited in most word processor and internet browser programs:

Artist: Misan Jones		Producer: CP		Client: Earth and Sky Productions	
Project Name: Being Here		Engineer: CP			
Title Name: Custody		Assistant:			
1) BD <small>Insert: Dyn/Eq 1</small>	2) Snare <small>Insert: Dyn/Eq 2</small>	3) HH <small>Insert: X Rack-Eq1</small>	4) Tom 1		
5) Tom 2	6) OH L	7) OH R	8) BassDI <small>Insert: X Rack-Dyn3</small>		
9) BsCab	10) A Guit	11) E Guit	12) Pno L		
13) Pno R	14) Vox 1 <small>Insert: Eq/Dyn 4</small>	15) BV 1	16) BV 2		
Project Summary: Recorded 30 Oct - 7 Nov 2006					
Title Summary:					
Device List 1) X Rack-Eq1 2) X Rack-Eq2 3) X Rack-Eq3 4) X Rack-Eq4 5) X Rack-Dyn1 6) X Rack-Dyn2 7) X Rack-Dyn3 8) X Rack-Dyn4 9) Pre-amp 10) Reverb 11) XLogic VHD Pre1 12) XLogic VHD Pre2 13) XLogic Comp1 14) XLogic Comp2 15) Insert 15 16) Insert 16			Chain List Dyn/Eq 1 X Rack-Dyn1, X Rack-Eq1 Dyn/Eq 2 X Rack-Eq2, X Rack-Dyn2 Eq/Dyn 2 X Rack-Eq2, X Rack-Dyn2 Eq/Dyn 1 X Rack-Eq1, X Rack-Dyn1 Eq/Dyn 3 X Rack-Eq3, X Rack-Dyn3 Eq/Dyn 4 X Rack-Eq4, X Rack-Dyn4		

The Total Recall Tab

The **Total Recall** tab is the second tab from the left in the Matrix Remote:



This tab controls the Matrix Total Recall function, which allows you to store and recall Matrix settings used in the Current Title. All of the settings on the desk which you are likely to need to remember are stored as part of the Total Recall snapshot, as listed on Page 73.

Note that the settings of any X-Racks which are connected to Matrix are also included in the Total Recall function. For X-Racks running software version 1.2/4 or below, up to 4 X-Racks can be included. For X-Racks running software version 1.3/0 or above, up to 6 X-Racks can be included. See your X-Rack manual for details of X-Rack Total Recall.

A number of the TR functions described over the following pages can be accessed directly from the Matrix console using the TR menu in the SSL soft keys. See Page 47 for more details.

Taking a TR Snapshot

To take a snapshot of the desk's settings, press the **Take TR Snap** button located to the right of the window. The snapshot will then appear in the current Title's snapshot list in the centre of the **Total Recall** window, as well as in the **Total Recall** folder in the **Projects** tab.

It is also possible to take a snapshot directly from the Matrix front panel via the TR set of SSL soft keys - see Page 45.

Naming a TR Snapshot

Snapshots are named '**TR n**' where '**n**' is the lowest unused TR number within that Title. However, you can edit this name by right clicking (Mac: ctrl+click) on the required snapshot and selecting **Rename** from the drop-down menu. Type the name in the **New Name** pop-up which appears, and press **OK**. Note that the snapshot number will be retained at the front of the snapshot name.

Deleting a TR Snapshot

To delete a snapshot, right click (Mac: ctrl+click) on the required TR and select **Delete** from the drop-down menu. Press **OK** in the warning pop-up which appears.

Recalling a TR Snapshot

Enabling Total Recall

Please note: We advise disabling Delta Control automation whilst TR is enabled - see page 55

In order to recall a snapshot of the desk's settings, Total Recall must be Enabled. This is done by pressing the **Display TR** button located at the top of the button list in the right of the tab, or by pressing Enable in the TR soft key menu (See Page 45). The current status of the Total Recall is shown above the **Display TR** button, by either a green **TR Disabled** sign or a red **TR Enabled** sign. In addition, the **TR** box in the bottom right-hand corner of the Remote window goes red to indicate when TR is enabled (as shown below).



The console also provides indication that TR is enabled via the red and green **AUTO** lights at the bottom of the channel meters: for any channel with no changes required, both lights will be on. For any channels which contain settings which do not correspond with the selected snapshot, the green light will be on and the red light will flash.

*Note that **AUTO** lights are also used for automation. See Pages 46 and 88 for details.*

Once TR has been enabled, the **Display TR** button becomes the **Disable TR** button.

Important Note: *When Total Recall is enabled, a number of LEDs on Matrix perform a different function from that performed during normal operation. Additionally, due to the quantity of information which has to be detected, the processing speed and sound quality of Matrix is significantly reduced when Total Recall is enabled. It is therefore important to disable Total Recall when you have finished resetting a snapshot.*

Selecting a TR Snapshot

There are three groups of settings within a TR Snapshot, listed on Page 66: Group 1 consists of switches and faders which can be reset automatically. Group 2 consists of switches which require manual resetting. Group 3 consists of pots which require manual resetting.

To select a TR snapshot, press the **Display TR** button to enable Total Recall, highlight the snapshot which you want to recall from the snapshot list in the centre of the **Total Recall** window, and press **Select TR Snap**. The console LEDs will now indicate whether or not they correspond to the selected snapshot: LEDs are unlit to indicate where the snapshot and console match, and lit to indicate where they do not. If all you want to do is recall a specific selection of settings without setting the snapshot to the whole desk or even a whole channel, this can now be done manually as described below.

Note that selecting a snapshot does not change any settings until a TR snapshot is 'set' (see next page). In the instance of a selective reset, those settings which would normally be reset automatically by 'setting' a snapshot (Group 1) can also be reset manually. In this case Group 1 controls function exactly as if they were part of Group 2. The exception to this is the faders which have no TR indication.

Setting a TR Snapshot

Once Total Recall has been enabled and a snapshot has been selected, 'Setting' the snapshot will reset all the automatically resettable switches and faders (Group 1 on the following page).

Note that the console will still indicate those settings which require manual resetting (Groups 2 and 3) as was activated by the initial selection of the snapshot.

There are two options for Setting a TR snapshot:

Pressing **Set TR to All Chans** resets all the automatic resets for the whole desk.

Pressing **Set TR to Chan** brings up the following pop-up which allows you to recall all the settings within the snapshot related to specific channels without resetting the whole desk:

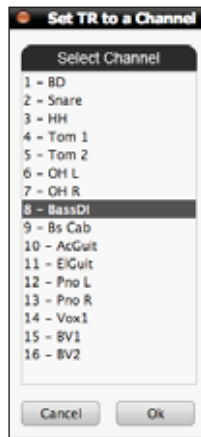

Select the channels which you want to reset, and press the **OK** button. All the automatic resets within those channels will now be reset.

Note that all functions concerned with Setting the currently selected TR Snapshot can be accessed directly from the Matrix front panel via the TR set of SSL soft keys - see Page 45.

Completing a Total Recall

Once the automatic resets have been set, the remaining switches and pots need to be manually reset in order for the snapshot recall to be complete. Below is a list of all the controls included within each TR group: automatic resets, manually reset switches and manually reset pots. The list is followed by an explanation of the resetting process for each group:

Grp 1: Auto Resets

- Channel Strip input selection, **CHOP** and Aux **SRC** buttons, Aux ON switches, **REC** and **CUE** bus routing, and **TRK** and **CUT** switches;
- All Bus Send **INSERT** and Σ switches;
- All faders.
- MIDI-Auto Status (None, Trim, Absolute)

Grp 2: Manual Switches

- Channel Strip **PHASE** and **INSERT** switches;
- **REC** and **CUE** bus master **TO MIX** switches;
- All **ST RET** switches except **AFL**;
- **Artist Monitor EQ** and **MONO** switches.

Grp 3: Manual Pots

- All Channel Strip pots apart from the V-Pot;
- All Bus Send Level pots;
- All **ST RET** pan/balance and level pots;
- **Artist Monitor EQ** pots and level control.

Group 1: Settings which Reset Automatically

When a snapshot has been selected and **Display TR** is active (see previous pages), the LEDs associated with any switches in the wrong position will light to indicate that they do not match the selected snapshot: for switches with two LEDs associated with them, such as **SRC** selectors, both LEDs will light. This TR indication can be used to manually reset a selection of settings without engaging a broader automatic reset. To do this, simply press the switch associated with any lit LED until there are no more LEDs lit.

Note that the faders have no TR indication and can therefore only be reset automatically.

When a snapshot is set, the desk automatically resets all of these settings, including the switches in the centre of the channel pots and those controlled from the Master Channel. However, if during the recall process one of these switches is pressed accidentally, their associated LEDs will light to indicate that their status no longer corresponds with the selected snapshot. Once none of these LEDs are lit, the Total Recall is complete for this group of switches.

Group 2: Switches Requiring Manual Resetting

Any switches which are mechanically latched require the operator to correct them manually. When a snapshot has been selected (see previous pages), if they are in a position other than that recorded in the snapshot, their **ON** LEDs light to indicate that they need switching. To complete the reset for this group, simply press the switch associated with any lit LED until there are no more LEDs lit. Once none of these LEDs are lit, the Total Recall is complete for this group of switches.

Group 3: Pots Requiring Manual Resetting

All the pots on Matrix controlling analogue signals require the operator to correct them manually. When a snapshot has been selected (see previous pages), if they are in a position other than that recorded in the snapshot, their Total Recall LEDs will light to indicate that the operator needs to move them manually. The Total Recall LED is the one immediately to the pot's right, linked by a thin white line. The LED lights green to indicate that the pot needs to be turned clockwise, or red to indicate that it needs to be turned anti-clockwise. To complete the reset for this group, simply correct the position of any pot which has a lit LED until there are no more LEDs lit. Once no Total Recall LEDs are lit, the Total Recall is complete for this group of settings.

*Note that the red **AUTO** LEDs below each channel meter will flash until all of that channel's controls are matched.*

Once you have taken the snapshot, don't forget to disable Total Recall by pressing the **Disable TR** button before continuing the session.

Copying and Swapping Data Between Channels

It is possible to copy the settings of one channel onto another channel, or to swap the settings of two channels with each other. To perform either of these functions, press the **Copy/Swap TR Data** button to produce the following pop-up:

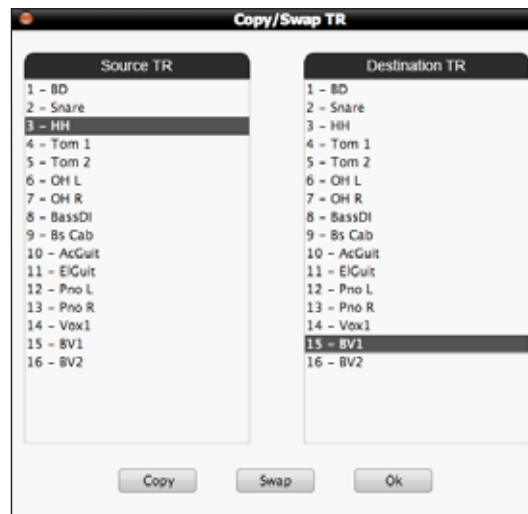

To copy a channel's settings to another channel, select the channel you want to copy in the left-hand **Source TR** column, select the channel to which you want to copy these settings in the right-hand **Destination TR** column, and press **Copy**.

To swap a channel's settings with another channel, select one of the channels in the **Source TR** column and the other in the **Destination TR** column, and press **Swap**.

Once you have made all of the copies and swaps you need to make, press **OK** to close the pop-up.

Manually reset switches and pots will now need to be reset. Automatically reset switches and faders can now be reset using either the **Set TR to All Chans** or **Set TR to Chan** buttons.

The Channels Tab

The **Channels** tab is the third tab from the left in the Matrix Remote. In this tab you can label the analogue channels on the Matrix control surface. Once again, this data is specific to the currently loaded Title. The main part of the window consists of a representation of a scribble strip:



To insert a channel name, simply click the scribble strip on the channel you wish to name, delete the current text and type the new name in. As you type, the name will appear in the Remote scribble strip, as well as in the digital scribble strip on the Matrix control surface located above the V-Pots. Once you have finished typing, your channel names are saved automatically.

Channel names can be a maximum of six characters long.

When in DAW Focus mode, the channel names will be generated by the names of the DAW tracks they are controlling. However, when a CC layer is active, the CC numbers can be labelled in the scribble strip, as described on Page 116.

See Page 84 for an explanation of Focus modes.

To blank all of the channel names, press the **Clear All** button underneath the scribble strip in the tab, and click **Yes** in the warning pop-up that appears.

To reset all the channel names to the default naming (Chan1, Chan2 etc), press the **Reset Channel Names** button underneath the scribble strip in the tab, and click **Yes** in the warning pop-up that appears.

If you are using the Cue Stereo to source extra inputs for **'32 Track Mixdown'** mode (see page 35) you can label both rows of the Matrix scribble strip so that you can remember what sources are having their level controlled by each Cue pot. Simply click the **Display Channels 17-32** button. Usefully, you can then choose **Flip Scribble Strip** so that the labels for channels 1-16 are closest to the faders and the labels for channels 17-32 are (slightly) closer to the cue pot.

Please note that you will only see both sets of labels on the Matrix scribble display when solely in Analogue Focus. If the Devices, Chains, In-Line, Plug-In or Auto-Set buttons are engaged or if you are in DAW Focus Mode, you will not see channel names 17-32.

Save And Load channel Names As A Preset

If you would like to re-use the channel names you have already typed in another Title, you can save your current Title's channel names as a preset.



Simply press the **Save Preset** button, in the top-right of the Channels Tab section. A window will then appear. Type in a name for this preset in the blank box at the bottom of the window and click **Save**.

Upon creating a New Title, the preset name will be available in a drop-down list. Or, if you create a New Title with default channel names and then realise you want to use one of the presets, simply go to the Channels Tab and click **Load Preset** then choose your preset name from the list and click **Load**.



Renaming And Deleting Saved Channel Name Presets



Right-clicking on a stored channel preset in the list allows it to be renamed or deleted. You can rename or delete from either the **Load** or **Save** pop-up window. The maximum amount of saved presets is 32.

The Insert Matrix Tab

The **Insert Matrix** tab of is the fourth tab in the Matrix Remote. This allows you to route external signal processing to your channel insert points.



See Chapter 1 for details of connecting up your external signal processing to the Insert Matrix sends and returns.

Note that the Insert Matrix only routes Devices within the channel insert points, and is isolated from the bus insert points.

Naming Devices

The Devices column on the right-hand side of the **Insert Matrix** tab lists the 16 devices available to you, with the default labelling, **Insert 1** to **Insert 16**. You can rename the Devices inside the Remote by right-clicking (Mac: ctrl+click) on the Device's insert number and pressing **Rename** in the drop-down which appears. Type the name you wish to give that unit in the **New Name** pop-up appears and press **OK**.

The Device number which precedes the name refers to the DEVICE SEND and RTN input and output to which the Device is connected.

Note that Matrix allows you to name different Devices with exactly the same name, in which case the Devices can be distinguished using the Device number.

Note also that if you attempt to save a blank Device name, the Remote will return the Device to its default name, **'Insert n'** where 'n' is the Device number.

Setting Devices as Stereo



Right-clicking on a device in the list will present the option **Set As Stereo**. Clicking this will automatically append the letter ‘L’ to the device label you have selected and will also add a ‘R’ to the next device in the list.

Setting a device as stereo means that you only have to click and drag once to move it into the Insert Matrix, as both devices are moved as one. For instance, setting Device 15 as stereo and then dragging it into Channel 11 will automatically insert Device 16 onto Channel 12.

To return a pair of devices to normal “mono” operation, right-click on either of the devices in the device list and select **Set As Mono**.

Inserting Analogue Devices Using The Insert Matrix

On the right-hand side, you have two buttons, **Devices** and **Chains**. Make sure **Devices** is selected and you will see your 16 analogue pieces of gear in either a red or black box. To insert a piece of analogue gear onto a particular channel, simply drag and drop (click and hold with a mouse-click) one of the devices currently available into the first available slot on your desired channel. Available devices are shown in **black**. Devices already in use are shown in **red**. The horizontal scroll bar at the bottom will allow you to move through all 16 channels of Matrix.

Please note that the Insert Matrix has no concept of an “empty slot”. So if you try and drag a device into the 6th slot and there are not devices in the 5 above it, it will automatically move up to fill the top slot.

Once inside the Matrix, devices can be freely dragged and dropped between channels. If you wish to move a device from Channel 1 to Channel 16, simply hover over the horizontal scroll bar whilst holding the mouse-click down to move across the Matrix.

Creating Chains On The Fly



Once you have a device inserted in the first slot, the second slot will become available for you to drag a device into. This way you can create chains of devices. For example, the screenshot above shows that the insert send of Channel 14 routes into the 4K EQ, out of the 4K EQ into the 4K DYN, out of the 4K DYN back to the insert return. A maximum of 6 devices can be used across a single channel.

Re-Ordering Adjacent Devices

To swap the order of two adjacent devices, pick up the first device with the mouse and then hover over the second. Release the mouse and they will swap slots.

Removing Devices

Right-clicking on a device in the Insert Matrix will give you three different options:

Remove selected device - Removes the selected device from the Insert Matrix and places it back into the devices list. Any devices below will shuffle up to fill empty slots.

Remove ALL devices from selected channel - Removes all devices in that channel, not just the one that was right-clicked on.

Remove ALL devices from Matrix - Removes all devices, across all channels of the Insert Matrix and returns them to the devices list. A pop-up window provides an extra chance to change your mind.

Saving Chains as Presets

If you build a chain that may be of use on another session, you can save this as a preset. For instance you have found a combination of devices that work well for a singer who may work with again. Click the **Save Chain** button which can be found at the bottom of each channel in the Insert Matrix. A pop-up window will appear asking you to name the chain. The chain will then be shown in the **Chain** list.

Please be aware that the Save Chain button is specifically for saving preset chains to be used at a later date. The Insert Matrix will continue to save automatically with the Title any time a change is made.

Channels with devices Set To Stereo are not available for saving as Chain Presets.

Loading Preset Chains from the Chains List



Click the **Chains** button at the top-right of the devices list to view your saved chains. The Chains list is split into two columns. The left column displays the names of your saved chains and the right column displays the names and order of devices of the selected chain. Click on the chain name in the left column to select the desired chain. Looking at the image above, you can see that two items in the chains list, **'4k Vocal 1 - Devs in use'** and **'4k Vocal 2'**.

'**Andy Vocal 1**' is greyed out because at least one of the devices in that particular chain is already in use elsewhere in the Insert Matrix. The right-hand column shows that the device in question is the **DBX 1** and it is being used on Channel 14. Right-click on the chain name in the left-hand column and choose **Release Assigned Devices**. This will un-route any devices needed by that particular chain and make them available again. The chain name will no longer be greyed out. Click and drag on the chain name itself (left-hand column) and move into the desired channel on the Insert Matrix.

Be sure to click and drag on the name of the chain and NOT the displayed chain order boxes.

Renaming and Deleting Chains

Right-clicking on the chain name will allow it to be renamed or deleted. A maximum of 32 preset chains can be stored.

Save and Load Entire Insert Matrix as a Preset

The **Save Preset** and **Load Preset** buttons at the top-right of the Insert Matrix tab allow entire Insert Matrix settings (including assigned devices, device names, chains and devices set as stereo) to be saved and loaded within each title.

This may be useful if you have a particular setup for tracking and a different setup for mixing. Instead of having to re-create these setups each time you open a New Title, you can simply save them as two presets.

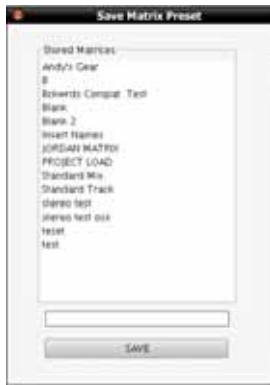

Clicking the **Save Preset** button will bring up a pop-up window. Type in a name for this preset into the blank box at the bottom of the window and click **Save**.

Upon creating a New Title, the preset will be available in a drop-down list. Or, if you create a New Title with a default Insert Matrix and then realise you want to use one of the presets, simply go to the Insert matrix Tab and click **Load Preset**, choose your preset name from the list and click **Load**.



RENAMING AND DELETING SAVED CHANNEL NAME PRESETS

Right-clicking on a stored channel preset in the list allows it to be renamed or deleted. You can rename or delete from either the **Load** or **Save** pop-up window. The maximum amount of saved presets is 32.



The Delta Tab

The **Delta** tab has optional features for Delta Control, and also allows you to switch between using Delta Control for analogue automation, or Legacy automation modes (see the MIDI method on page 59, and the AFADA method on page 61).



Automation mode

This allows switching between Legacy automation (the A-FADA / MIDI method) and Delta automation modes. To switch automation mode select either **Legacy** or **Delta**, then restart the console using the **Restart** button at the bottom of the Delta tab.

Motors Off Mode

The **Touch Enable** button will toggle the ability to drop into writing automation when in motors off mode. For more details see page 58.

Show Fader Levels

The **Meter Enable** button will toggle display of the fader (DCA) levels on the the right-hand channel meters when writing Delta automation. This is particularly useful when the **MOTORS OFF** option is engaged, as the fader level can still be viewed even though the physical fader is disengaged. For more details, see page 58.

Chapter 5 - DAW Control

Introduction

A wide range of DAW packages, along with associated MIDI devices such as soft synths and certain hardware instruments, can be controlled directly from Matrix's front panel, allowing you to run sessions with significantly less reliance on a mouse and keyboard. This control data is received via networked MIDI connections, using one of two standard MIDI control surface protocols: HUI primarily used by Pro Tools, and MCU which is supported by Logic and Cubase/Nuendo amongst others. A wide range of commands are included within these protocols, including transport control, channel and plug-in parameters, and various global commands. Other MIDI devices can be controlled using standard Continuous Controller (CC) MIDI messages, which are generated by the Matrix channel faders, encoders and switches when the 'CC' protocol is selected. Each DAW layer also supports up to 5 sets of programmable Soft Keys (see Chapter 6). These can be programmed with either DAW specific MIDI commands or keyboard shortcuts. The combination of these two control protocols provides a powerful and practical method to achieve tactile control of a workstation or editor.

For DAW software other than Pro Tools, Logic, and Cubase/Nuendo please refer to their operational documentation to confirm which protocol they support.

This chapter describes how the Matrix console employs these control protocols, introducing the front panel controls and covering any elements of the interface which are not standard to the protocols. For descriptions of the specific functions contained within these protocols and the standard controls associated with them, please refer to the MIDI Controller section of your DAW's operation manual.

This chapter presumes that the appropriate default Profiles have been assigned to the DAW layers, as described in the layer configuration section of Chapter 1.

Layers

Matrix can connect to up to four DAW's or software MIDI devices, one from each of four virtual 'layers'. Each layer can be assigned to use a particular 'Profile'. Selecting a Profile will assign the layer to use one of the three control protocols and load a set of Soft Key assignments, which can be customised to suit your operational needs. This is covered in more detail in Chapter 6. Control operations performed on the Matrix control surface will then affect whichever program is assigned to the currently selected layer.

Note that the DAWs or MIDI devices do not have to be on the same computer.

Matrix Console Layer Selection

The layers are assigned and configured in the Matrix Remote's **DAW** tab, as described in Chapters 1 and 6. However, selecting a layer in the Remote does not select that layer on the Matrix console. The layer which is being controlled from the Matrix console is selected using the **DAW LAYER SELECT** buttons, located in the Matrix centre section, below the digital scribble strip (shown right). The selected button lights to indicate that it is active. Layer 1 is active when none of the buttons is lit. If you wish to use Layer 1 and another layer is selected, press the lit button to return to Layer 1.

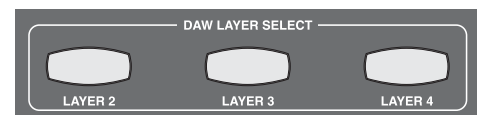

Focus Modes

In order to provide the analogue routing and DAW control capabilities of Matrix within a compact space, the console can operate in two 'Focus' modes, focusing on either the analogue or DAW control functions. These modes are simply called Analogue Focus and DAW Focus.

Focus modes primarily affect the channel faders and their **CUT** and **SOLO** buttons which control the analogue signal when in Analogue Focus mode, but send control messages to the DAW when in DAW Focus mode. Focus modes also affect the channel meters which meter the analogue signal in Analogue Focus mode but replicate the DAW track metering in DAW Focus mode.

Note that it is possible to lock the meters to either the analogue channel or DAW track signals regardless of the console's Focus mode. This is done via the Meter menu in the SSL soft keys. See Page 44 for more details.

Matrix's mode is selected and indicated by the large light-blue Focus button, located directly underneath the Master Channel, on the left of the centre section (at the bottom of the graphic on the right). Pressing this button switches between Focus modes. It is lit to indicate Analogue Focus, and unlit to indicate DAW Focus.



Note: It is important to distinguish between DAW Focus mode (where the desk's channels control the tracks within the DAW) and DAW input selection within Analogue Focus mode (where the desk's channels control the analogue signals returning from the DAW).

Normally the console master fader controls the main mix level in Analogue Focus or the main output level in DAW Focus if the active DAW layer uses the MCU Protocol (the HUI protocol does not support a master fader). The **MF FOCUS** button, located above and to the right of the main fader (shown right), allows one channel fader from the opposite Focus mode to appear in place of the master fader:

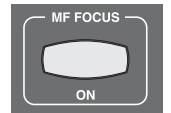

When in DAW Focus mode with **MF FOCUS** selected, pressing the upper (analogue) **SEL** button in any channel assigns the master fader, along with its **CUT** and **SOLO** buttons, to that analogue channel.

When in Analogue Focus mode with **MF FOCUS** selected, the master fader controls whichever DAW track is currently selected in the DAW. The master fader can therefore be assigned to a different DAW track using the lower (DAW) **SEL** buttons. The **BANK** and **CHANNEL** keys can be used to access DAW channels outside the current set of channels assigned to the 16 fader strips. See Page 90 for details.

Pressing the **IN-LINE** button, located in the **V-POTS MODES** area of the centre section, allows both DAW and analogue faders to be active in the same Focus mode by reassigning control of the faders from the currently inactive mode to the V-Pots below the digital scribble strip. See Page 86 for details.

DAW Track Control

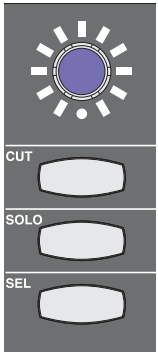

A number of the parameters within the tracks of your DAW can be controlled using the lower section of the Matrix channel strip. The Matrix controls which can be used in this way include:

- The blue shaft encoder located below the digital scribble strip, called the V-Pot,
- The momentary switch in the centre of the blue pot, called the V-Sel,
- The **CUT**, **SOLO** and **SEL** buttons located beneath the blue pot,
- The channel fader.

The functions of the V-Pot, V-Sel button and **SEL** button are defined by the protocol-specific assignment soft keys. Additional options and modes are available via **V-POT MODE** and **SEL KEY** buttons described on Pages 76 and 77.

When in DAW Focus mode, the channel **CUT** button mutes the DAW track which that channel is currently controlling, and the channel **SOLO** button solos the DAW track which that channel is currently controlling. The **CUT** and **SOLO** buttons light when pressed to show that they are active, just as in Analogue Focus mode. The presence of a solo button within the DAW tracks is indicated by the **CUT** buttons on all unsoloed tracks flashing, and by the **SOLO** LED to the left of the 2-digit **Mode** display also flashing.

*Please note that there are two **SEL** buttons in the Matrix channel. The other **SEL** button is located further up the channel strip, above the digital scribble strip, and is concerned with the desk's analogue routing, not DAW control.*

*Note that in DAW mode, the channel **SOLO** mode is defined by the DAW, and that the analogue and DAW solo functions have separate centre section solo indicators.*

The Digital Scribble Strip

The digital scribble strip that runs across the centre of the desk consists of two display rows. By default, the top row contains labels associated with the channel faders, and is therefore Focus mode dependent: In Analogue Focus mode it displays the channel names defined in the **Channels** tab of the Matrix Remote (switching to a momentary display of the fader value in dB when a fader is moved), whereas in DAW Focus mode the top row normally displays the DAW track names.

If the desk is in Analogue Focus and the **DISPLAY 17-32** is box is enabled in the **Channels** tab of the Remote, channel names 17-32 will hi-jack the bottom row of the scribble strip and replace the DAW track names. **FLIP SCRIBBLE STRIP** will then allow the two rows of channel names to be reversed, so that 17-32 are shown on the top row.

*Please note that the **FLIP SCRIBBLE STRIP** on the Channels tab is independent to the **FLIP SCRIBBLE STRIPS** option on the DAW tab, which is specific to DAW scribble strip information. Read below to find out more about this.*

The bottom row of the scribble strip is associated with the V-Pot located beneath the scribble strip. When Matrix is assigned to a layer controlling a DAW, the bottom row of the scribble strip displays either the name or the value of the parameter controlled by the V-Pot. When controlling Pro Tools, the scribble strip only displays the name of the V-Pot. For DAWs controlled via the MCU protocol, please refer to their control surface documentation for full details of their scribble strip displays and messages.

In order to cater for variations in the ways MCU DAWs return channel data, there is a **Flip Scribble Strips** box in the **DAW** tab of the Remote, located to the right of the **Edit Profiles** button. This switches the two rows of the scribble strip, allowing Nuendo labelling to follow the Logic format. **Flip Scribble Strips** is enabled for the Nuendo default Profile and disabled for the Logic default Profile. For other MCU DAWs, the labelling format described in their control surface documentation will enable you to ascertain whether or not to activate this function.

See Page 116 for a description of the scribble strip in CC layers.

V-Pot Modes

The channel V-Pots can function in a number of different ways, as controlled by the V-Pot mode keys mapped to the soft keys in the DAW Profile assigned to the current layer. Each of the default Profile contains a full set of V-Pot mode keys mapped to the default soft key set. These master keys allow the V-Pots to control a variety of workstation console functions including panning, sends and plug-in parameters. When using the MCU protocol, the 2-digit **Mode** display next to the timeline counter provides additional user feedback on V-Pot modes.

V-Pot mode functionality will be fully described in the control surface documentation supplied with the DAW.

Each V-Pot is surrounded by a circular **||** segment parameter value indicator with a red LED immediately underneath the V-Pot to indicate default value settings or the state of the integral V-Pot switch. Full information will be found the DAW control surface documentation.

As well as the modes defined by the DAW protocol, Matrix offers additional V-Pot functionality via the four console **V-POT MODES** keys, located above the Utility and Navigation areas of the Matrix centre section. Each of these buttons lights to indicate when they are active, with normal operation indicated when no lights are on.

Flip Mode

The **FLIP** button sends the MCU Flip command or the HUI Shift command, allowing certain function on the V-Pots to be controlled by the faders. In Pro Tools, the **FLIP** function allows send levels to be controlled from the channel faders with the channel V-Pot, **CUT** and **SOLO** buttons controlling additional send functions, including panning on stereo sends and the send mute function. The send slot being controlled is displayed in the top row of the digital scribble strip.



When controlling a DAW via the MCU protocol, the **FLIP** function interchanges or duplicates most V-Pot parameters on to the faders including plug-ins and Instruments - full details will be found in your DAW control surface documentation.

IN-Line Mode

IN-LINE assigns the V-Pot to control either the analogue channel output level or the DAW track level depending on the current console Focus mode, replacing the current function assigned to the V-Pot: In DAW Focus mode, the channel fader controls the DAW track level and the V-Pot the analogue channel level, whereas in Analogue Focus mode, the channel fader controls the analogue channel level and the V-Pot controls the DAW track level.

With **IN-LINE** mode enabled, the top row of the digital scribble strip contains the fader labels and the bottom row the V-Pot labels. With neither **V-SOLO** nor **V-MUTE** active, the V-Sel button swaps the function of the fader and V-Pot within that channel. This swap is indicated by the Track and Channel labels reversing position.

The last two **V-POT MODE** keys determine the function of the V-Sel switches when **IN-LINE** is active. The channel **CUT** and **SOLO** buttons are always linked to the channel fader, whether it is in Analogue or DAW Focus mode. If **V-SOLO** is selected, the V-Sel switch becomes the solo button for the signal, which is being controlled by the V-Pot. Similarly, if **V-MUTE** is selected, the V-Sel switch becomes the mute switch for the signal which is being controlled by the V-Pot. In either mode, the red LED beneath the V-Pot lights to indicate that the **V-SOLO** or **V-MUTE** function has been activated.

V-MUTE and **V-SOLO** intercancel. A second press on the active mode switch returns the V-Sel switches to channel swap function.

V-SOLO and V-MUTE functions only work when the IN-LINE button is active. If IN-LINE is not active, these will function as buttons for DEVICES and CHAINS mode in analogue operation. Please refer to Chapter 3 for information on this.

SEL Key Modes

The Matrix offers additional DAW control functionality via the **SEL KEY** area of the Matrix centre section, located above the Utility keys. Each of the **SEL KEY** buttons lights to indicate when it is active. There are four **SEL KEY** modes:

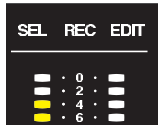
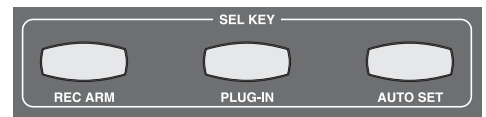

In Default mode, active when no other mode is selected, the channel DAW **SEL** buttons select the corresponding track within the DAW. The **SEL** symbols at the top of the channel meters light to indicate which track (or tracks) have been selected.

Rec Arm Mode

In **REC ARM** mode, each **SEL** button arms and disarms the corresponding DAW track's record ready function. The **REC** symbols at the top of the channel meters flash to indicate which tracks are record-armed.

Plug-in Mode (Pro Tools Only)

PLUG-IN mode allows you to control the parameters of your Pro Tools track's plug-ins from the Matrix front panel. In this mode, the V-Pots, V-Sels and the digital scribble strip no longer control DAW track function, but emulate the dedicated HUI plug-in controller. This consists of four encoders with integral switches, a two-line 40-character parameter display, plus additional switches to assign and control the plug-ins within a Pro Tools channel strip.

Note that the alignment of some of the labels in the digital scribble strip is approximate.

Full details of HUI plug in control can be found in the Pro Tools MIDI Control Surfaces guide. The following description provides a brief overview of the functionality.

With **PLUG-IN** mode enabled, the channel DAW **SEL** keys can select and indicate the channel currently selected to the plug-in editor.

*Note that due to changes in recent Pro Tools software (V7.0 and above) selecting a channel via the **SEL** keys only works for tracks assigned to faders 1 to 8. It is often easier to select the plug-in by clicking on send slot in the mixer page. This will automatically assign the plug in to the Editor and open the plug-in window on screen.*

The track selected to the **PLUG-IN** controller is displayed in the top half of the digital scribble strip above channels 9-16. The **Edit** symbol in the top right hand corner of the channel's meter area (shown above left) also lights to indicate that one of its sends is being edited.

V-Sel 16 switches between Insert and Param mode, and the red LED below the V-pot lights to indicate Param mode. Insert mode is used to select which insert (1- 5) is being configured, and Param allows the parameters of the selected plug-in to be controlled.

Insert Mode

V-Pot 16 scrolls between the Inserts 1-4 page and the Insert 5 page. The current page is indicated in the top row of the scribble strip. In the Inserts 1-4 page, Inserts 1-4 can be accessed by pressing V-Sels 9, 10, 11 and 12. In the Insert 5 page, Insert 5 is accessed via V-Sel 9. The selected insert label will flash to indicate that it has been selected.

Channel 15's V-Sel button switches Assign mode on and off, and the red LED below the pot flashes when Assign mode is on. In Assign mode, the V-Pot for each insert scrolls through a full list of available plug-ins, with the LEDs around the V-Pot indicating how far through the list you have scrolled. Once the desired plug-in has been located, it can be assigned to the track insert by pressing the associated V-Sel button.

Param Mode

Param mode, activated either by pressing V-Sel 16 or by pressing any of the inserts which are currently assigned, brings the parameters of the plug-in on the currently selected track insert into the plug-in editor. The plug-in parameters are accessed using V-Sels and V-Pots 9, 10, 11 and 12. The upper row of the scribble strip displays any parameter switch options controlled by the V-Sels, and the lower row on the scribble strip displays the parameters controlled by the V-Pots. In Param mode, V-Pot 16 scrolls between the pages of plug-in parameters. When a new page is accessed, the current page is displayed momentarily (along with the number of parameter pages) in the top row of the scribble strip, in Channels 9 and 10.

V-Sel 7 and 8 are always assigned to the Bypass and Compare functions of the plug-in.

Auto Set Mode

AUTO SET mode allows you to change the automation status of the DAW tracks via the console V-Sel switches. In this mode, the V-Pots have no function and the V-Sels no longer control their corresponding DAW track.

For MCU DAWs, **AUTO SET** assigns the four Logic MCU automation commands to V-Sel switches 1-4, repeating them on V-Sels 9-12. These modes are labelled on the bottom row of the scribble strip directly above the V-Pot. The Automation Mode on the currently selected channel will be indicated by all the indicator LEDs illuminating around the V-Pot whose V-Sel switch corresponds to the active automation state. To change mode, simply operate the V-Sel switch for the new mode. Selecting the OFF state from an active mode requires the READ switch to be selected twice. Use the appropriate global modifier key in conjunction with the V-Sel switch to toggle the automation state of all tracks.

*Note the above explanation refers to changing automation modes in Logic. **AUTO SET** may not be fully supported by other MCU controlled DAWs. Please consult the relevant documentation to determine if automation control supports the same controller codes as Logic.*

In Pro Tools, **AUTO SET** functions as follows:

When **AUTO SET** is pressed, the bottom row of the digital scribble strip for Channels 1-6 and 9-14 displays the Pro Tools automation modes, while the top row of the digital scribble strip displays the currently active Pro Tools track names. When a channel's DAW **SEL** key is pressed, the track name in the scribble strip is replaced by a display of that track's current automation mode. The track's automation mode can now be altered by pressing the V-Sel buttons below each of the automation mode labels.

You will notice that the red **AUTO** LED above that channel strip indicates the automation status of the DAW track in that channel: the LED flashes when any of the write modes are selected and stays lit when a track is actively writing automation data. The green **AUTO** LED indicates Read Mode; Flashing red + green LEDs indicates if the trim state has been selected for any of the write modes (Pro Tools HD only).

Either set of V-Sel buttons (ie. those found in Channels 1-6 or 9-14) can be used to set the automation mode on any active DAW track. The automation mode on a range of tracks can be set together by selecting multiple **SEL** keys. This is done by holding the left-most DAW **SEL** key and pressing the right-most **SEL** key within the desired selection. In **AUTO SET** mode, the channel faders retain their control of the DAW track faders and the mode can safely be left enabled in order to change state whilst Pro Tools is in Play.

*Please note that there are two **SEL** buttons in the Matrix channel. The other **SEL** button is located further up the channel strip, above the digital scribble strip, and is concerned with the desk's analogue routing, not DAW control.*

*Note that in Pro Tools, automation of send level and pan functions can be accessed by pressing **AUTO SET** while in **FLIP** mode (see Page 86).*

Transport Controls

Your DAW's transport can be controlled from the five dedicated transport buttons on Matrix control surface, located at the bottom of the centre section:

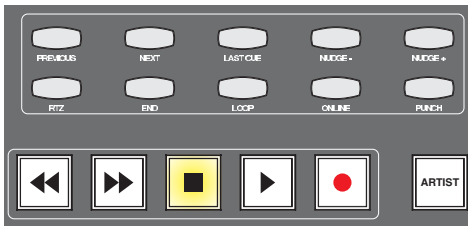

The large buttons at the bottom of the transport area, with the exception of the button marked **ARTIST**, operate the rewind, fast forward, stop, play and record, functions in the same way as the DAW's own on screen transport keys.

Above these large buttons are two rows of five smaller buttons which control more advanced transport functions such as marker navigation and nudging. These are labelled for use with the Pro Tools Profile, and are mapped to the nearest equivalent function in the default Profiles for other DAWs, as detailed in the function map in Appendix A. The function assignments of these buttons can be edited via the **Transport/Utility** page of the **Soft Key Set** area in the **DAW** tab, described on Page 113.

You will find definitions of these transport functions in your DAW's control surface documentation, with the exception of **PREVIOUS**, **NEXT**, and **LAST CUE** which function as follows:

Note that these functions are Pro Tools specific.

- **PREVIOUS**, located to the left of the top row, takes the cursor to the timeline marker numbered one lower than that which was last selected using the **PREVIOUS** and **NEXT** buttons.
- **NEXT**, located to the right of **PREVIOUS**, takes the cursor to the timeline marker numbered one higher than that which was last selected using the **PREVIOUS** and **NEXT** buttons.
- **LAST CUE**, the middle button in the top row, returns the cursor to the marker last selected using the **NEXT** button.

For example, if the marker previously selected using these buttons was Marker 4, **PREVIOUS** would move the cursor to Marker 3, **NEXT** to Marker 5, and **LAST CUE** back to Marker 4. On session startup, pressing any of these buttons will take the cursor to Marker 1.

These additional transport functions appear in the HUI **MIDI CMDS** list in the DAW tab as **Next Marker**, **Prev Marker**, and **Last Marker** respectively.

The internal Matrix marker counter can be reset using the **Reset Marker** soft key found in the HUI **MIDI CMDS** list in the **DAW** tab (see Page 109).

Session Counter

The counter for the DAW timeline is shown in the numeric display above the digital scribble strip in the centre section.

The two digit mode display to the left is used only by MCU DAW's that support it. The larger counter to the right displays whichever counter format is selected in the DAW, the format is indicated using the LEDs to the right of the counter.

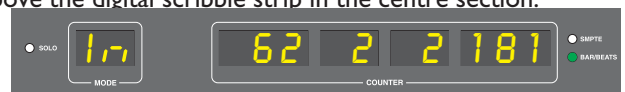

Utility Buttons

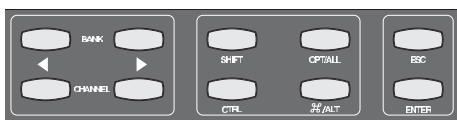

Above the transport controls, there are another two rows of five buttons:

The **BANK** cursors cycle through the tracks in the DAW session 16 at a time. The **CHANNEL** cursors cycle through the tracks in the DAW session one at a time.

*Note that when using Logic, the tracks in the session may not appear on Matrix in the order that they are displayed in the **ARRANGE WINDOW** unless the **ARRANGE Channel Strip View mode** is selected in the Logic control surface set up menu.*

Note that the DAW analogue inputs to Matrix are fixed. Cycling through the DAW tracks will therefore result in any physical alignment of the tracks in the DAW and the analogue returns to Matrix to be lost.

The Modifier keys (**SHIFT**, **CTRL**, **OPT/ALL** and **⌘/ALT**) as well as the **ESC** and **ENTER** keys are protocol-specific and are shown on the front panel with their default HUI labels. In addition to these buttons there are two further utility buttons, **SAVE** and **UNDO**, located to the right of the main session counter. These simply replicate the DAW Save and Undo functions.

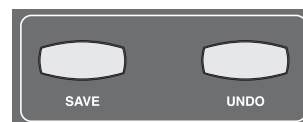

The functions assigned to these keys in the Pro Tools, Logic and Nuendo/Cubase default Profiles are listed in the function map in Appendix A and can be changed using the DAW Profile tab in the Matrix Remote.

Note that some of these keys will not function with some DAWs.

Navigation Controls

Matrix's navigation controls can be used to navigate around the DAW session and to enable additional transport monitoring functions such as Scrub and Shuttle (HUI only). They consist of the large navigation wheel in the bottom right hand corner of the console with four mode buttons above it, and the five buttons above them known as Cursor keys, comprising four directional keys and a central **MODE** selector.

The navigation wheel performs a number of different functions, depending on which mode has been selected using the four mode buttons above the wheel.

For DAW's controlled via the MCU protocol, the default mode of operation for the wheel is to scroll the timeline through the session. **JOG** mode selects the MCU **SCRUB** mode to audibly monitor tracks by 'scrubbing' them in the timeline. **TRACKS** re-assigns the wheel to scroll the Matrix faders through all the tracks in the session. It is provided as an alternative to the utility **BANK** and **CHANNEL** keys (see above). **SHUTTLE** and **NUDGE** are not supported.

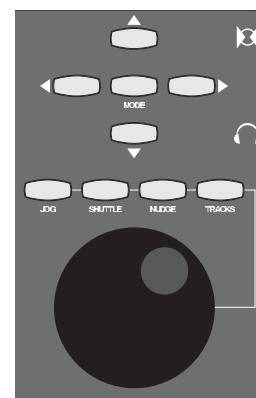

When controlling Pro Tools, with no Mode selected, the Wheel will also scroll through the session timeline with a resolution and speed derived from the Timeline display format in use. Selecting **NUDGE** allows timeline control using the current 'nudge' value and can also be used to nudge a selected clip(s). **JOG** and **SHUTTLE** engage the corresponding Pro Tools functions as detailed in the Pro Tools Control Surfaces manual. However please note that a number of Pro Tools functions are disabled when either **JOG** or **SHUTTLE** are active. To exit a mode, either deselect the function or press the transport Stop key. **TRACKS** re-assigns the wheel to scroll the Matrix faders through all the tracks in the session. It is provided as an alternative to the utility **BANK** and **CHANNEL** keys.

The Cursor keys perform a number of DAW specific operations in conjunction with the **MODE** key located in the centre of the Cursor key group. Note that **MODE** function is a single level control in the MCU protocol and has two levels of operation in the HUI protocol, indicated by the **MODE** button being lit steady-state or flashing.

Standard Profile Soft Key Assignments

Soft Key Overview

In the main control section of the console is a two row LCD display with 8 switches above and below. All of these 16 'Soft Keys' can be programmed to send either DAW specific MIDI commands or keyboard shortcuts. The top row can also be programmed to act as 'Menu' keys for the lower row of switches, up to 5 sets of Soft Keys can be stored with each Profile. The Standard Profile for each protocol includes a suggested set of keys for the top, or Default, set. Some profiles may come with more keys assigned to the User 1 and User 2 layers. The assignments for the standard layer is described below for each of the default Profiles.

Chapter 6 describes how to customise the Soft Key assignments to suit your own needs.

Please refer to your DAW's HUI or MCU protocol section of their manual for a full understanding of control capabilities.

Pro Tools Standard Profile

Main Soft Key Page

Below are the assignments for Matrix' Standard key set. You are in the Standard Key Set when the User 1, User 2, User 3 or User 4 keys are not selected.



< Prev	Locates to previous marker
Next >	Locates to next marker
V-Pot	Opens the V-Pot menu
I/O	Opens the I/O menu
MemLoc	Opens/closes the Memory Locations window
Big C	Opens/closes the Big Counter window
AutoEn	Opens the AutoEn Menu
AWind	Opens the Automation Window
Edit	Brings the Edit window to the foreground
Mix	Bring the Mix window to the foreground
Sus G	Suspends/Suspends Groups
Plugs	Shows/hides the Plug-In window of selected plug-in
Trans	Shows/hides transport window
RecRdy	Record-ready for all tracks
P Roll	Toggles Pre and Post Roll on/off
Click	Toggles the metronome on/off

The V Pot Menu

The image below shows the assignments for the V-Pot Submenu.



Pan	V-Pots control Pan levels (hold OPT modifier whilst moving to see value)
Mute	Changes push function of V-Pots between Muting sends or Pre/Post
Dfault	Default faders/pan positions. Press and hold whilst pressing a channel's SEL key
Assign	Enters/Exits the HUI Assign mode for Plug-ins and I/O assignments
Send A	V-Pots control Send A levels
Send B	V-Pots control Send B levels
Send C	V-Pots control Send C levels
Send D	V-Pots control Send D levels

The I/O Menu

The image below shows the assignments for the I/O Submenu.



Assign	Enters/Exits the HUI Assign mode for Plug-ins and I/O assignments
Input	Allows assign mode to set channel inputs
Output	Allows assign mode to set channel outputs
-----	Unassigned
-----	Unassigned
-----	Unassigned
-----	Unassigned
-----	Unassigned

The AutoEn Menu

The image below shows the assignments for the AutoEn Submenu.



Fader	Enables/disables Fader automation
Mute	Enables/disables Mute automation
Pan	Enables/disables Pan automation
Send	Enables/disables Send automation
SMute	Enables/disables SMute automation
Plugin	Enables/disables Plugin automation
AutoS	Enables/disables all automation
-----	Unassigned

The User 1 Menu

The image below shows the assignments for the User 1 Submenu.



< Tab	Tabs to previous transient (providing Tab To Transient is enabled)
Tab >	Tabs to next transient (providing Tab To Transient is enabled)
SelTab	Tabs to next transient and also highlights area (providing Tab To Transient is enabled)
Z Out	Vertical Zoom Out for all tracks
Z In	Vertical Zoom In for all tracks
Cut	Cut highlighted region
EdMode	Cycles selection of Pro Tools' edit modes - Shuffle, Spot, Slip and Grid
EdTool	Cycles selection of Pro Tools' editing tools
Edit	Brings the Edit window to the foreground
Mix	Bring the Mix window to the foreground
Tab T	Enables/disables Tab To Transient
Sel R	Selects all regions on track
Split	Separates region at playhead
Copy	Copy highlighted region
Paste	Paste copied region
Click	Toggles the metronome on/off

The User 2 Menu

The image below shows the assignments for the User 2 Submenu.



Intro	Enters a marker that names itself to 'INTRO'
Verse	Enters a marker that names itself to 'VERSE'
Chorus	Enters a marker that names itself to 'CHORUS'
Mid 8	Enters a marker that names itself to 'MIDDLE 8'
BrkDwn	Enters a marker that names itself to 'BREAKDOWN'
Outro	Enters a marker that names itself to 'OUTRO'
MemLoc	Opens/closes the Memory Locations window
Delete	Deletes the last entered Memory Location(s)
-----	Unassigned

The User 3 Menu

The image below shows the assignments for the User 3 Submenu.



Drums	Opens/closes the Drum Names Submenu
Bass	Opens/closes the Bass Names Submenu
Keys	Opens/closes the Keys Names Submenu
Guitar	Opens/closes the Guitar Names Submenu
String	Opens/closes the Strings Names Submenu
Vocals	Opens/closes the Vocals Names Submenu
Perc	Opens/closes the Percussion Names Submenu
FX	Opens/closes the FX Names Submenu
-----	Unassigned

The Drum Names Menu

The image below shows the assignments for the Drum Names Submenu.



Kick	Types in the name 'KICK' followed by enter. Double tap 'SEL' key to enter name dialogue before pressing this.
Snr T	Types in the name 'SNR T' followed by enter. Double tap 'SEL' key to enter name dialogue before pressing this.
Snr B	Types in the name 'SNR B' followed by enter. Double tap 'SEL' key to enter name dialogue before pressing this.
Tom 1	Types in the name 'TOM 1' followed by enter. Double tap 'SEL' key to enter name dialogue before pressing this.
Tom 2	Types in the name 'TOM 2' followed by enter. Double tap 'SEL' key to enter name dialogue before pressing this.
Hats	Types in the name 'HATS' followed by enter. Double tap 'SEL' key to enter name dialogue before pressing this.
OHS	Types in the name 'OHS' followed by enter. Double tap 'SEL' key to enter name dialogue before pressing this.
Room	Types in the name 'ROOMS' followed by enter. Double tap 'SEL' key to enter name dialogue before pressing this.

Transport/Utility Keys

The image below shows the assignments for the Matrix's transport/utilities section.



PlayFS	Play command is assigned to first footswitch connection
RecFS	Record command is assigned to second footswitch connection
Shift	Shift command (HUI)
Ctrl	Ctrl command (HUI)
Alt	Alt command (HUI)
Option	Option command (HUI)
Enter	'Enter' (Return on Mac) key on keyboard
F8	Cycles Pro Tools edit tools
Save	Saves session
Undo	Undo
Previous	Locates to previous marker
RTZ	Locates to session start
Next	Locates to next marker
End	Locates to region end
Last	Locates to last locator
Loop	Turns loop playback on/off
Nudge -	Nudge left by Nudge value
Nudge +	Nudge right by Nudge value
Online	Toggles Online Sync on/off
Q Punch	Toggles Quick Punch record on/off

List of HUI Functions

The ProTools profile contains a mixture of HUI commands and USB keyboard shortcuts. To help you see how we have renamed the commands, see the table below.

BLACK Text = HUI command

RED Text = USB keyboard shortcut

DAW CMD / KBD Shortcut	Softkey Label (Re-named)	DAW CMD / KBD Shortcut	Softkey Label (Re-named)
Prev Marker	< Prev	Apple+X	Cut
Next Marker	Next >	Edit Mode	EdMode
---	V-Pot (Menu)	Edit Tool	EdTool
---	I/O (Menu)	Alt+Apple+Tab	Tab T
Apple+Numeric keypad 5	MemLoc	Apple+A	Sel R
Apple+Numeric keypad 3	Big C	Apple+E	Split
---	AutoEn (Menu)	Apple+C	Copy
Apple+Numeric keypad 4	AWind	Apple+Y	Paste
Edit to foreground	Edit	Numeric Enter + 'INTRO' + Enter	Intro
Mix to foreground	Mix	Numeric Enter + 'VERSE' + Enter	Verse
Shift+Apple+G	Sus G	Numeric Enter + 'CHORUS' + Enter	Chorus
Open/close plugin editor	Plugs	Numeric Enter + 'MID 8' + Enter	Mid 8
Open/close transport	Trans	Numeric Enter + 'BREAKDOWN' + Enter	BrkDwn
Rec/Rdy all	RecRdy	Numeric Enter + 'OUTRO' + Enter	Outro
Apple+K	P Roll	Apple+Z	Delete
Numeric keypad 7	Click	Shift/All	Shift
Pan	Pan	Option/All	Option
Mute	Mute	Control	Ctrl
Default	Dfault	CMD/Alt/Fine	Alt
Assign	Assign	Fkey8/Esc	Esc
Send A	Send A	Play Foot Switch	PlayFS
Send B	Send B	Record Foot Switch	RecFS
Send C	Send C	RTZ	RTZ
Send D	Send D	End	End
Input	Input	Last Marker	Last
Output	Output	Loop	Loop
Auto Enable Fader	Fader	KPad +	Nudge -
Auto Enable Pan	Mute	KPad -	Nudge +
Auto Enable Send	Pan	On-line	Online
Auto Enable Send Mute	Send	Quick Punch	QPunch
Auto Enable Plugin	SMute	Save	Save
Auto Enable Plugin	Plugin	Undo	Undo
Auto Suspend	AutoS	Rewind	Rewind
Alt+Tab	< Tab	Forward	Forward
Tab	Tab >	Stop	Stop
Shift+Tab	SelTab	Play	Play
Ctrl+Alt+Down Arrow	Z Out	Record	Record
Ctrl+Alt+Up Arrow	Z In		

Logic Standard Profile

Main Soft Key Page

The image below shows the assignments for Matrix's Standard key set. You are in the Standard key set when the User 1, User 2, User 3 and User 4 keys are not selected.



Mixer	Opens/Closes the Mixer
AView	Shows/Hides automation lane data
TkZoom	Zooms track by set amount
Func	Accesses the Func Submenu
Marker	Creates/Deletes Markers (push and hold function)
Nudge	Nudges selected region (push and hold function)
SMPTE	Changes timecode display between SMPTE or Bar/Beats
Delete	Deletes selected region
NM/VAL	Switches V-Pot display between labels/values.
Track	Globally changes V-Pots through various 'Track' options (has push and hold function)
PanSur	V-Pots control pan parameters (has push and hold function)
Send	V-Pots control send parameters (has push and hold function)
EQ	Opens standard Logic EQ strip on selected channel (Has push and hold function)
Plugin	V-Pots control Plug-ins
Instr	V-Pots control Virtual Instruments
Click	Turns the metronome on/off

The Func Submenu

The following image shows the assignments for the Func Submenu.



F1	Opens Screenset 1
F2	Opens Screenset 2
F3	Opens Screenset 3
F4	Opens Screenset 4
F5	Opens Screenset 5
F6	Opens Screenset 6
F7	Opens Screenset 7
F8	Opens Screenset 8

The User 1 Submenu

The following image shows the assignments for the User 1 Submenu.



Snip	Cuts section between locators (Arrange page)
Silenc	Inserts silence between locators (Arrange page)
Splice	Inserts snipped section at playhead (Arrange page)
Repeat	Repeats section between locators (Arrange page)
Split	Splits regions/events by playhead position (Arrange page)
Loop Region	Turns loop on/off for selected region (Arrange page)
Mute	Mutes selected region (Arrange + MIDI page)
Delete	Deletes selected region (Arrange + MIDI page)
Select	Select Tool (Arrange + MIDI page)
Pencil	Pencil Tool (Arrange + MIDI page)
Eraser	Eraser Tool (Arrange + MIDI page)
TxtFng	Text/Finger Tool (Arrange + MIDI page)
Scisor	Scissors Tool (Arrange + MIDI page)
Glue	Glue Tool
ASelct	Automation Select (Arrange + MIDI page)
ACurve	Automation Curve (Arrange + MIDI page)

Transport/Utility Keys

The following image shows the assignments for the Transport/Utility section of Matrix.



PlayFS	Play command is assigned to the first footswitch port
RecFS	Record command is assigned to the second footswitch port
Shift	Keyboard Shift (follow key state)
Ctrl	Keyboard Ctrl key (follow key state)
Cmnd	Keyboard Cmnd key (follow key state)
Alt	Keyboard Alt/Option (follow key state)
Scrub	Puts jog wheel into Scrub mode
Enter	Keyboard Enter key
Cancel	Cancel
Save	Saves project
Undo	Undo
EQ	Opens standard Logic EQ strip on selected channel (Has push and hold function)
PrevMk	Locates to previous marker
NextMk	Locates to next marker
Cycle	Turns cycle on/off
Punch	Turns Autopunch on/off
RTZ/Start	Go to selection start (track region must be selected first)

List of MCU Functions

The Logic profile contains a mixture of MCU commands and USB keyboard shortcuts. To help you see how we have renamed the commands, see the table below.

BLACK Text = MCU command

RED Text = USB keyboard shortcut

DAW CMD / KBD Shortcut	Softkey Label (Re-named)
Instr	Instr
Plugin	Plugin
EQ	EQ
PanSur	PanSur
Send	Send
Track	Track
KeybID	KeybID
x	Mixer
a	AView
z	TkZoom
Menu	Func
Marker	Marker
Nudge	Nudge
SMPTE/Beats	SMPTE
Backspace	Delete
Name/Value	NM/VAL
Track	Track
PanSur	PanSur
Send	Send
EQ	REQ
Plugin	Plugin
Instr	Instr
Click	Click
Ctrl+Cmnd+X	Snip
Ctrl+Cmnd+Z	Silenc
Ctrl+Cmnd+Y	Splice
Ctrl+Cmnd+R	Repeat
/	Split
L	Loop
M	Mute
Backspace	Delete
Esc>1	Select
Esc>2	Pencil
Esc>3	Eraser
Esc>4	TxtFng

DAW CMD / KBD Shortcut	Softkey Label (Re-named)
Esc>5	Scisor
Esc>6	Glue
Esc>Q	ASelct
Esc>W	ACurve
F1	F1
F2	F2
F3	F3
F4	F4
F5	F5
F6	F6
F7	F7
F8	F8
Play Foot Switch	PlayFS
Record Foot Switch	RecFS
Shift (Follow Key State)	Shift
Cmnd (Follow Key State)	Cmnd
Ctrl (Follow Key State)	Ctrl
Alt (Follow Key State)	Alt
Cntl + .	NextMk
Cntl + ,	PrevMk
Cycle	Cycle
Rewind	Rewind
Forward	Forwrd
Stop	Stop
Play	Play
Record	Record
Enter	Enter
Cancel	Cancel
Save	Save
Undo	Undo
Scrub	Scrub
Punch	Punch
Shift + Return	RTZ/Start
Drop	Drop

Nuendo Standard Profile

Main Soft Key Page

The image below shows the assignments for Matrix’s Standard key set. You are in the Standard key set when the User 1, User 2, User 3 and User 4 keys are not selected.



AUTO	Opens the Automation Submenu
EDIT	Opens the Edit Submenu
DEVICE	Opens the Device Submenu
PAN*	Sets the V-Pots as Pan controls and shows the values
SOLDEF	Solo Defeat
DELETE	Deletes selected Regions/Notes/Automation Data
ADD	Adds Marker at cursor position
TRSP	Shows/hides transport panel
MIXER	Shows/hides the Mixer
E	Opens channel settings
EQ	V-Pots control the channel EQ
INSERT	V-Pots assign and control plug-ins on the selected track
FXSEND	V-Pots control Send levels
PAGEDN	Pages backwards through plugins or other functions with multiple parameters
PAGEUP	Pages forwards through plugins or other functions with multiple parameters

The Auto Submenu

The following image shows the assignments for the Auto Submenu.



PANEL	Shows the Automation Panel
READ	Set selected track to Read mode
WRITE	Set selected track to Write mode
G-READ	Toggles automation Read status for all tracks
G-WRIT	Toggles automation Write status for all tracks
-----	Unassigned

The Edit Submenu

The following image shows the assignments for the Edit Submenu.



COPY	Copy selected region/event/note
PASTE	Paste selected region/event/note
DUPL	Duplicate selected region/event/note
DELETE	Delete selected region/event/note
QUANT	Quantise selected region/event/note
CUT	Cut selected region/event/note
M2C	Set locators to selected region/event
X	Crossfade

The Device Submenu

The following image shows the assignments for the Device Submenu.



VSTCON	Opens VST Connections window
INSTRM	Opens VST Instruments window
PERFOR	Opens VST Performance window
TRSP	Opens Transport window
V-KEY	Opens Virtual Keyboard
-----	Unassigned

The User 1 Submenu

The following image shows the assignments for the User 1 Submenu.



1	Numeric Keypad 1
2	Numeric Keypad 2
3	Numeric Keypad 3
4	Numeric Keypad 4
5	Numeric Keypad 5
6	Numeric Keypad 6
7	Numeric Keypad 7
8	Numeric Keypad 8
9	Numeric Keypad 9
0	Numeric Keypad 10

Transport/Utility

Keys

The following image shows the assignments for the Transport/Utility section of Matrix.



SHIFT	Keyboard Shift (follow key state)
CTRL	Keyboard Ctrl (follow key state)
CTRL A	Keyboard Ctrl+A
ALT	Keyboard Alt/Option (follow key state)
ESC	Keyboard Escape
ENTER	Keyboard Enter
PREV	Locate to previous marker
NEXT	Locate to next marker
RTZ	Locate to session start
RIGHT	Locate to session end
CYCLE	Engage/disengage loop function
NUDGE -	Unassigned
NUDGE +	Unassigned
SYNC	Turn sync on
PUNCH	Engage/disengage punch-in record mode

Further useful information will be found in the Mackie Control and Nuendo manual from Steinberg.

List of MCU Functions

The Cubase/Nuendo profile contains a mixture of MCU commands and USB keyboard shortcuts. To help you see how we have renamed the commands, see the table below.

BLACK text = MCU command

RED text = USB keyboard shortcut

DAW CMD / KBD Shortcut	Softkey Label (Re-named)
-	AUTO (Menu)
-	EDIT (Menu)
-	DEVICE (Menu)
Pan + Name/Value	PAN**
C	CLICK
Solo Defeat	SOLDEF
backspace	DELETE
Add	ADD
F2	TRSP
Mixer	MIXER
Edit	E
EQ	EQ
Inserts	INSERT
FX Sends	FXSEND
Page Down	PAGEDN
Page Up	PAGEUP
F6	PANEL
Read	READ
Write	WRITE
Alt+R	G-READ
Alt+W	G-WRIT
Ctrl+C	COPY
Ctrl+V	PASTE
Ctrl+D	DUPL
backspace	DELETE
Q	QUANT
Alt+X	CUT
P	M2C
X	X

DAW CMD / KBD Shortcut	Softkey Label (Re-named)
F4	VSTCON
F11	INSTRM
F12	PERFOR
F2	TRSP
Alt+K	V-KEY
Numeric Keypad 1	1
Numeric Keypad 2	2
Numeric Keypad 3	3
Numeric Keypad 4	4
Numeric Keypad 5	5
Numeric Keypad 6	6
Numeric Keypad 7	7
Numeric Keypad 8	8
Numeric Keypad 9	9
Numeric Keypad 0	0
Shift (follow key state)	SHIFT
Ctrl (follow key state)	CTRL
Ctrl A	CTRL A
Alt (follow key state)	ALT
Esc	ESC
Enter	ENTER
Previous	PREV
Next	NEXT
,	RTZ
Right Arrow Key	RIGHT
Cycle	CYCLE
Nudge -	NUDGE -
Nudge +	NUDGE +
Sync	SYNC
Punch	PUNCH

CC (Continuous Controller) Standard Profile



Snap	Takes a snapshot of the current values of the Matrix faders, V-Pots and switches.
Rest	Resets the Matrix faders, V-Pots and switches to the values saved in the last snapshot and sends these as MIDI data to the Workstation.
Refresh	Sends the current positions and state of Matrix faders, V-Pots and switches as MIDI data to the Workstation.

Chapter 6 - DAW and CC Configuration

In this chapter, we will examine how the standard DAW Profiles covered in Chapters 1 and 5 can be customised, focussing on the configuration of the four DAW control layers and associated soft keys. We will also cover the configuration of CC (Continuous Controller) layers for the control of MIDI devices. Layers and soft key assignments for both DAW and CC layers are stored on the SD memory card in the rear of the console, and are configured in the **DAW** tab in the Matrix Remote:



Note that the programming described in this chapter is part of the global configuration of Matrix and is therefore not stored within specific Titles.

Note also that instructions for the initial configuration of your DAW layers can be found in Chapter 1.

Matrix Console Layer Selection

The layers are defined and configured in the Matrix Remote's **DAW** tab, as described below. However, selecting a layer in the Remote does not select that layer on Matrix console. The layer which is being controlled from the Matrix console can then be selected using the **DAW LAYER SELECT** buttons, located in the Matrix centre section, below the digital scribble strip (shown right). The selected button lights to indicate that it is active. Layer 1 is active when none of the buttons is lit. If you wish to use Layer 1 and another layer is selected, press the lit button to return to Layer 1.

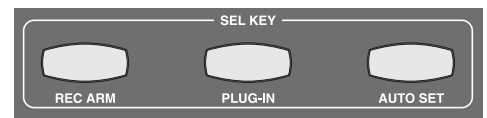

Matrix Remote Layer Selection

The layer being configured in Matrix Remote is selected via the **DAW** tab's **Layer** radio buttons, located in the middle of the tab towards to top. All other functions in this tab, with the exception of the **Transport Master** selection, are specific to the selected layer.

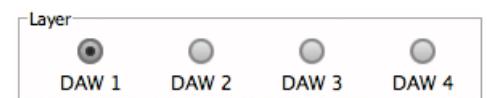

Assigning DAW Layers

Selecting Profiles

In order to use a DAW layer, you must first load a Profile onto it.

A Profile defines which control protocol (HUI, MCU or CC) is used to control the DAW or MIDI device, and also includes its own five sets of soft keys set up for a specific DAW program. There are four standard Profiles supplied with Matrix:

- A HUI Profile configured for Pro Tools,
- An MCU Profile configured for Logic,
- An MCU Profile configured for Nuendo/Cubase,
- A Continuous Controller (CC) Profile for use with MIDI devices.

These Profiles provide starting points for the creation of more personalised Profiles. They include only basic soft key assignments, allowing plenty of space for the user to configure their own Profiles. Profiles for other DAW packages can also be created from the standard Profiles, using the Pro Tools standard Profile for DAWs that support the HUI interface, and the Logic standard Profile for DAWs that conform to the MCU protocol. Note that the standard Profiles themselves cannot be edited. Profiles are personalised by creating standard Profile copies which can then be edited, as described on the following pages.

The soft key assignments included in the standard Profiles are described on Pages 91 to 97 and the full list of functions available within each protocol can be found in Appendix A.

Profiles are selected and managed using the **Profile Setup** area, found in the top left corner of the **DAW** tab. The four standard Profiles are listed in the drop-down **Selected Profile** menu, along with any derivatives of them which you have created (see below). By default, Matrix layers contain no preassigned Profiles. The user must therefore select a Profile before the system can control a DAW.

If the Profile you select uses a different protocol than that currently assigned to the layer selected in the Remote, or if the layer previously contained no Profile, a pop-up will appear asking you to restart the Matrix console. Press **OK**.

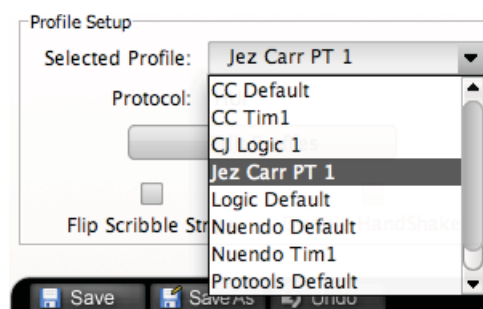

Note that further Profile selections can be made before performing this restart. However, a number of functions within the DAW tab will be locked out until the restart is complete.

Once all the necessary Profiles having been assigned to the required layers, cycle the power to the Matrix console to perform the restart.

Note that, depending on the complexity of your setup, you may need to re-find Matrix in the Remote after the restart. This is described on Page 11.

In order to cater for variations in the ways MCU DAWs return channel data to the digital scribble strip, there is a **Flip Scribble Strips** box in the **DAW** tab of the Matrix Remote, located to the right of the **Edit Profiles** button. This switches the two rows of the scribble strip, allowing Nuendo labelling to follow the Logic format. **Flip Scribble Strips** is enabled for the Nuendo standard Profile and disabled for the Logic standard Profile. For other MCU DAWs, the labelling format described in control surface documentation will enable you to ascertain whether or not to activate this function.

Creating Profiles

To create a new Profile, press **Edit Profiles** to bring up the **Profile Editor** pop-up:

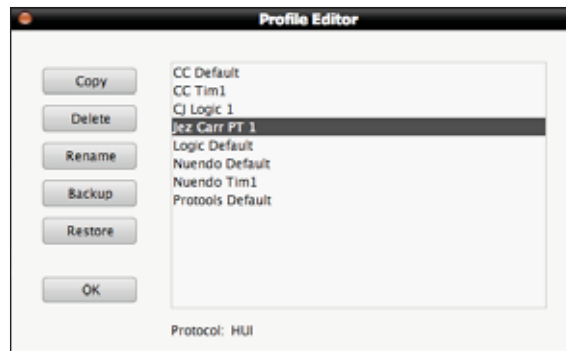

Select the Profile which you wish to use as a starting point and press **Copy**. Type a name for the new Profile into the **Copy Profile** pop-up which appears, and press **OK**:

After a moment, the new Profile will appear in the Profile list in the **Profile Editor**. In order to ensure that the underlying protocol of a Profile (HUI, MCU or CC) is not forgotten when it is not present in the Profile name, the selected Profile's protocol is indicated at the bottom of the pop-up, as well as underneath the **Selected Profile** in the **Profile Setup** area of the main **DAW** tab.

Press **OK** to exit the **Profile Editor**.

You can now select the new Profile using the layer selection and Profile selection functions described on the previous pages.

There is a second way to create your own Profile, using the **Save As** button in the **Soft Key** area which makes up the bottom half of the **DAW** tab:

First select the Profile you want to use as a starting point and assign it to a layer, as described on the previous pages.

Press the **Save As** button below the **Edit Profiles** button to bring up the **Save Profile As** pop-up. Type a name for the new Profile into the pop-up and press **OK**. After a moment, the new Profile will be created and become active in that layer. In order to ensure that the underlying protocol of a Profile (HUI, MCU or CC) is not forgotten when it is not present in the Profile name, the selected Profile's protocol is indicated underneath the **Selected Profile** in the **Profile Setup** area of the main **DAW** tab.

Deleting Profiles

To delete a Profile, press **Edit Profile** to bring up the **Profile Editor** pop-up, select the Profile which you wish to delete, and press **Delete**. Press **OK** in the warning pop-up which appears, and after a moment the Profile will disappear from the list in the pop-up. Press **OK** to exit the **Profile Editor**.

Renaming Profiles

To rename a Profile, press **Edit Profile** to bring up the **Profile Editor** pop-up and select the Profile which you wish to rename. Press **Rename** to bring up the **Rename Profile** pop-up. Type a new name for the Profile into the pop-up and press **OK**. The Profile's name will change in the Profile list in the **Profile Editor**.

Backing Up a Profile

To back up a Profile or export it for use in another Matrix Remote, press **Edit Profile** to bring up the **Profile Editor** pop-up, select the Profile which you wish to back up, and press **Backup**. In the pop-up which appears, edit the name and destination of the file if necessary, and press **Save**. Your Profile will be exported as a .zip file.

Restoring a Profile

To restore a Profile from back-up or import a Profile created in another Matrix Remote, press **Edit Profile** to bring up the **Profile Editor** pop-up and press **Restore**. In the pop-up which appears, locate the Profile .zip file you wish to restore and press **Open**. The restored Profile will appear in the Profile list. If the Profile name already exists the restored filename will be appended with numeral to distinguish it from any parent Profile of the same name. You can now rename the Profile as described above.

Disable Handshake

The **Disable Handshake** box below the **Edit Profiles** button in MCU layers will only be of use in systems where there are multiple MCU layers in use, and where these layers include both Logic and other MCU programs. Checking this box stops MCU programs from handshaking with each other via Matrix, preventing Logic from scanning for external controllers and subsequently creating ghost controllers of any other MCU programs.

*Note: The console must be restarted if the **Disable Handshake** status is changed for a Profile before the change will take effect*

Selecting the Transport Master

Normally Matrix will output transport commands to whichever DAW is assigned to the currently selected layer. However, if you are controlling more than one DAW, there may occasions when the Transport controls need to be locked to a specific DAW which is acting as the master timeline for any other DAWs being controlled.

This is done by selecting the layer containing the master DAW within the **Transport Master** area of the Remote's **DAW** tab. The selected transport master becomes active as soon as it has been selected and will always receive commands generated by the five primary Transport keys, the ten soft keys located directly above the main Transport keys and the Navigation wheel and mode switch.



If **None** is selected within the **Transport Master**, Matrix will output the transport controls to the DAW on the currently selected layer.

Note that a DAW Transport master is not required when controlling multiple DAWs that are connected as 'ReWire' slaves to the Master DAW.

Soft Keys

The soft key area of the desk is located below the counter display in the centre section, and comprises 16 buttons above and below the digital scribble strip which runs across the whole desk:

There is a vast array of functions which can be assigned to these buttons, and the scribble strip in between them indicates what functions are currently assigned to them: the upper row of the display refers to the row of buttons above it, and the lower display to the row of buttons below it.

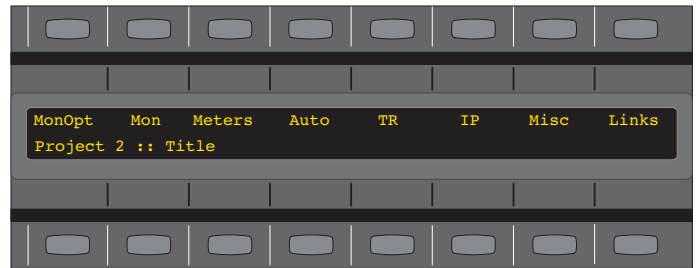

DAW Control Protocols, USB Commands and Menus

There are two types of message which these soft keys can be programmed to send: commands within the HUI and MCU protocols described above, and any QWERTY commands which you might send from your computer's normal keyboard, such as DAW quick keys. These keyboard commands are not sent via the Ethernet MIDI ports, but via the USB cable connecting Matrix to the computer. MIDI CC layers can only contain USB soft keys or Matrix commands.

Please refer to Chapter 1 for instructions for setting up MIDI and USB connections.

In addition to MIDI and USB commands, the top row of soft keys can be used as menu selectors for the bottom row, enabling each button in the top row to access up to eight separate commands assigned to the buttons on the bottom row.

Soft Key Sets

Each DAW layer has five soft key sets, providing plenty of space to tailor the control of each DAW package independently. The sets are called '**Standard**' and '**User 1**' to '**User 4**'. The supplied standard Profiles come pre-programmed with a number of typical functions appropriate to the DAW which that layer controls, allowing you to get started with Matrix before you have programmed all your soft keys. The combination of sets and menus allows a maximum of 360 functions to be assigned to the soft keys of all five sets.

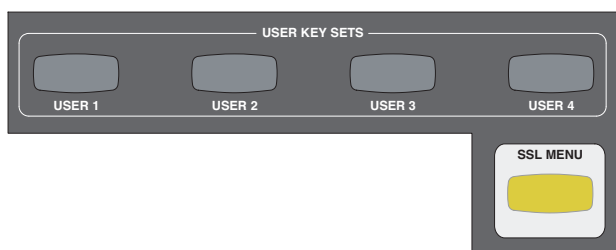

The soft key set which is currently active in the soft keys is selected using the buttons in the **SOFT KEY SETS** area of the centre section, located below and to the right of the soft keys themselves.

In addition to the five programmable sets, there is also a further system set labelled **SSL** which is used for accessing global settings and options for the Matrix console.

Pressing one of these buttons simply activates that set of soft keys, and pressing another button will replace the old selection with the new. The standard set is active when none of the buttons are lit, and can be reactivated when not active by pressing whichever soft key set button is lit.

Note that the SSL soft key button overrides the USER soft keys. Selecting user-defined soft keys while the SSL set is active will not activate that soft key set until the SSL button is deselected. The SSL soft keys are described on Page 42.

Programming Soft Keys

Soft keys are programmed from the **DAW** tab in the Matrix Remote:



Across the middle of the **DAW** tab's window is a row of radio buttons marked **Soft Key Set**. These buttons select which set of soft keys is present in the lower part of the window for editing. The five normal soft key sets, **Standard** and **User 1** to **User 4**, are all edited in exactly the same way within the **DAW** tab. The **Transport/Utility** set functions slightly differently and will be dealt with on Page 113.

Below this row of buttons is a representation of the soft keys section of the Matrix control surface called **Soft Key Setup**, showing the 16 buttons and the central display, with current assignments indicated in the display. Six dashes in the display indicate that the button is currently unassigned within this soft key set.

In the left-hand top corner of the **Soft Key Setup** area are the **Save**, **Save As** and **Undo** buttons, and towards the right-hand top corner are the **Show Sub Keys** box (see Page 111) and saved data **Status** indicator. The **Status** indicator shows whether or not there are unsaved changes within the present soft key set. Assignments must be saved using the **Save** or **Save As** button in order for them to become active on the Matrix control surface. Unsaved changes can also be cancelled using the **Undo** button. Switching between soft key sets will lose any unsaved changes, and a pop-up window will appear, offering the option of **Save** and continue or **Cancel** the set switch.

Soft key assignments only appear in the Matrix soft keys once they have been saved.

Assigning DAW Protocol Functions

To assign a HUI or MCU function to a button, select the relevant **Soft Key Set** in the Remote's **DAW** tab and press the button you wish to assign. The button will go yellow to indicate that it is being edited. From the drop-down menu which appears, selecting **DAW CMDS** produces a second drop-down which lists all the control commands available to you within the selected Profile:



Select the required command from the list, and its name will appear in the appropriate part of the tab's soft key display. Soft key assignments must be saved before they become active in the Matrix soft keys. If there are any unsaved changes when you try to exit the current **Soft Key Set**, a pop-up will appear inviting you to save changes before exiting. Press **No** to exit without saving your changes, or **Yes** to save changes and remain in that soft key set.

Assigning QWERTY Keystrokes

Soft keys can be assigned single keystroke commands, or more complex combinations such as modified commands. To assign a keyboard stroke, select the relevant **Soft Key Set** in the **DAW** tab and press the button you wish to assign. The button will go yellow to indicate that it is being edited. From drop-down menu which appears, selecting **Key assign** produces the **Keyboard Shortcut Setup** pop-up window which records your keystrokes in order to replicate them when the soft key is pressed.

Press the **Learn** button to start recording your keystrokes. The button will darken to indicate that it is recording. Now press the key, or combination of keys, which you want that soft key to emulate. The **Keyboard Shortcut Setup** window will display the depression and release of every key you press in the sequence in which they happen. Key releases are distinguished from key depressions by the presence of a caret symbol (^) immediately before it.

If you make an error, press **Cancel** and start again. Once you have completed the sequence correctly, press **Learn** again to stop the recording, followed by **OK** to close the **Keyboard Shortcut Setup** box. Soft key assignments must be saved before they appear in the Matrix soft keys.



First Key Modifier

Selecting the **First Key Modifier** box before pressing **Learn** causes any modifier release signals to be delayed until **Learn** is pressed again. This allows key combinations which the computer will recognise and hijack to be programmed without the associated control message actually being sent. For example, to program **⌘+Tab** on a Mac, without causing the computer to switch between programs:

- Select the **First Key Modifier** box;
- Press **Learn**;
- On the QWERTY keyboard, press and release **⌘**.
- On the QWERTY keyboard, press and release **Tab**;
- Deselect **Learn**.

You will notice that the **⌘** release does not appear in the pop-up until after the **Learn** button is deselected.

Follow Key State

Selecting the **Follow Key State** box before pressing **Learn** causes the Matrix to recognise an on and an off state to the assigned button. This is useful when you need to assign a modifier key (e.g. Option/Control/Alt/Shift) and it needs the ability to recognise when you are holding it down with your finger. Under normal circumstances, if you assigned a keyboard modifier to a button and did not select **Follow Key State** first, it would simply register a single message (equivalent to pressing and releasing the key straight away).

The 'Cubase/Nuendo Standard' profile comes pre-assigned with **Follow Key State** modifier messages.

Creating Soft Key Menus

To create a menu of soft keys, select the relevant **Soft Key Set** in the **DAW** tab and press the button in the top row which you wish to use to access the menu. The button will go yellow to indicate that it is being edited. From drop-down menu which appears, selecting **Menu** sets that button as a menu selector which can now be used to access a menu of eight functions using the eight bottom-row buttons.

Clicking the **Show Sub Keys** box to the left of the **Soft Key Setup** saved data **Status** indicator will blank the scribble strip in the Remote, leaving only those top row buttons which have been set to be menu selectors. All buttons with the exception of those assigned as menu selectors will now be disabled. The **Show Sub Keys** box will be checked (X) to indicate that you are assigning functions within the sub keys of a menu. In the example shown below, the fourth and fifth soft keys from the left have been assigned as menu selectors:



Select the button whose menu you wish to edit, and it will go yellow to indicate that it is being edited. The scribble strip will then contain dashes above the eight lower buttons, indicating that they are available for assigning:



You can now assign functions to the eight bottom-row buttons in the normal way, as described above. Once you have created the soft key assignments for this menu, pressing another top row button that has been assigned as a menu selector will switch the sub keys in the bottom row to that menu selector. The newly selected menu button will light to indicate that it is now the one being edited. Once you have completed the soft key assignments within all the menus, deselect the **Show Sub Keys** box to return the window to normal operation.

Soft key assignments must be saved before they become active on the Matrix console.

Renaming Soft Key Assignments

Every time you assign a soft key in any of the ways described above, they are named automatically:

- **DAW CMDS** functions are labelled according to the function you have chosen, as listed in Appendix A;
- Keyboard shortcuts are named '**USB n**' where '**n**' is the lowest number currently unused among the USB soft key labels;
- Menu selectors are named '**Menu n**' where '**n**' reflects the position of the soft key in the top row, counted from the left.

To rename a soft key, go to the relevant **Soft Key Set** in the **DAW** tab and press the button you wish to rename. The button will go yellow to indicate that it is being edited. From drop-down menu which appears, selecting **Rename** brings up the **Keycap Name** pop-up. Type the new name in the box provided (using a maximum of six characters) and press **OK**. Once the **Soft Key Set** has been saved, the new names will appear in the Matrix soft key area.



Assigning Modified Functions to Soft Keys

Soft keys can be set up to send more than one command, enabling modifiers to be assigned to the same soft key as the function which they are modifying. Once the first command has been assigned, further commands are assigned in exactly the same way. The soft key is then named according to the most recent assignment made, with an asterisk (*) added after it to indicate that there are multiple assignments on that soft key. The button can then be renamed in the normal way, though it will retain its asterisk to remind you that there are multiple functions assigned to it. Hovering over the button will bring up a list of all the commands assigned to that button.

When the soft key is pressed, the key ON signals are sent in the order in which they are programmed, and the key OFF signals are sent in the reverse order. In other words, if **SHIFT** is the first command and Play the second, then when the button is pressed it will send **SHIFT ON - Play ON**, and when it is released it will send **Play Off - SHIFT OFF**. This means that modifiers need to be programmed before the function they are modifying. Up to three modifiers can be added to a command function on one soft key.

Note that modifiers can only be assigned within the same command type as its modified function: DAW CMDS or Key assign.

Note that menu selectors cannot be part of multiple soft key assignments. Reassigning a menu selector will cause that menu selector and its soft key contents to be lost.

Removing and Replacing Soft Key Assignments

In most instances, if a new command is assigned to a soft key, the new command will replace the old command. However, in order to allow for the modified function assignments described above, replacing a **DAW CMDS** function with another **DAW CMDS** function will require the previous function to be removed first, otherwise the new function will simply be added to the old one.

To remove the assignment of a soft key, select the relevant **Soft Key Set** and press the button whose assignment you wish to remove. The button will go yellow to indicate that it is being edited. From drop-down menu which appears, select **Unassign**. The scribble strip will return to a line of dashes, indicating that there is no function assigned to it and that it is available for reassigning.

In order to protect menus and all their sub-keys from being removed accidentally, a warning pop-up will appear when a menu is removed or replaced, allowing the action to be cancelled.

Editing Transport and Utility Button Assignments

In addition to the main 16 soft keys, the function of 18 other buttons and the two foot switch inputs can be edited, increasing the total number of assignable soft keys within the four layers to 380. This is likely to be useful if you are using DAW packages which do not have suitable equivalents for certain functions used in the Pro Tools, Logic or Nuendo/Cubase Profiles. It may also be that the way you work means that there are some controls which you never use and other functions which would be more usefully accessed from those buttons.

The 18 buttons which are editable in this way are:

- The ten buttons above the main transport controls, the top left of which is labelled **PREVIOUS**,
- The six right-most utility buttons located above them, the top left of which is labelled **SHIFT**,
- The **SAVE** and **UNDO** buttons located above and to the right of the main soft key area.

Note: The functions assigned to these buttons in the standard Profiles are described on Pages 89 and 90.

To edit these button assignments, press the **Transport/Utility** radio button at the right-hand end of the **Soft Key Set** row in the **DAW** tab, bringing up a representational display of these buttons:



The buttons in the tab are distinguished by the Matrix console labels above each button. The current button assignments are indicated below each button. If the button is currently unassigned, the label below the button will consist of six dashes.

These buttons are assigned in exactly the same way as the normal soft keys.

Note that Transport and Utility keys cannot be assigned to be Menu selectors.

Foot Switch Commands

The **Foot Switches** buttons in the middle of the **Transport/Utility** window allow the two momentary foot switches which can be connected to the Matrix to have any USB or listed DAW command assigned to them. Both the HUI and MCU protocols contain dedicated codes for use with foot switches which actuate the DAW transport Play and Record functions. These are shown in the command list as **Play Foot Switch** and **Record Foot Switch**.

In addition, there is an extra SSL command which has been created specifically for use with the foot switch: **Artist Talkback Switch** enables the talkback function of the **Artist** button to be assigned to a foot switch.

Note that the foot switch must be held down to keep talkback open.

KVM Hot Key

The **KVM Hot Key**, located towards the top left of the **Transport/Utility** window, does not appear on the Matrix console. The button is only used on setups where there is more than one computer connected to Matrix. The **KVM Hot Key** can be programmed with a command to a USB KVM switch, telling it to switch between computer ports. When programmed, it outputs a USB command whenever its layer is selected using the console's **DAW LAYER SELECT** buttons, telling the KVM switch to select the USB port connecting to the computer on which the layer's DAW or MIDI device is hosted. The specific commands used by your KVM switch should be found in its operating manual.

Configuring CC Layers

When a CC Profile is assigned to a Matrix layer, CC messages are sent on Channel 1 of the first send port assigned to that layer. These messages can be used to control software instruments within the current DAW, using the DAW's MIDI 'learn' mode to attach the Matrix controllers to instrument plug-in parameters. Alternatively, an external hardware MIDI device can be controlled by assigning it to the output of a MIDI track in the DAW whose input is receiving the control data from a Matrix CC layer. Logic provides a further mechanism to integrate external MIDI hardware via the capabilities of the Logic Environment.

CC Layers are unidirectional. No CC data is returned from the device to Matrix and all front panel positional indication is derived locally, not from the device itself. Matrix controls are mapped to CC numbers as follows:

- Faders 1-16: CC's 0-15
- V-Pots 1-16: CC's 16-31
- **SEL** switches 1-16: CC's 64-79
- V-Sels 1-16: CC's 80-95

Faders and V-Pots output the full range of controller values 0-127.

Note that the V-Pots function as absolute controllers, not as incremental devices.

The **SEL** and V-Sel switches emulate latched switches sending appropriate ON and OFF values as they change state:

- ON = 127,
- OFF = 0.

The ON state is indicated by the switch tally: The V-Sel switch uses the red led located beneath the V-Pot, and the **SEL** switch uses the light in the switch and the **SEL** symbol in the meter bridge.

Please refer to your MIDI device's manual for instructions regarding mapping these CC numbers within the MIDI device.

CC Snapshots

In addition to the snapshots which can be taken of the Matrix control surface via Total Recall, snapshots can also be taken of the status of the CC values which are being sent to a MIDI device from Matrix. This is done using the three assignable soft keys in the **DAW CMDS** list of a CC layer, which are pre-assigned in the supplied CC standard Profile:

Take Snapshot takes a snapshot of all the CC values currently held in the Matrix control surface. The snapshot is automatically saved as part of the Profile. Only one snapshot can be saved in a Profile. If more than one snapshot is required, each one will require its own Profile. Profiles can be copied using the **Edit Profiles** pop-up, as described on Page 105.

Restore Snapshot restores the saved snapshot to the Matrix and therefore to the MIDI device.

Refresh sends the current Matrix CC values to the MIDI device.

The Digital Scribble Strip

The digital scribble strip that runs across the centre of the desk consists of two display rows. By default, the top row contains labels associated with the currently selected Focus mode: In Analogue Focus mode it displays the channel names defined in the **Channels** tab of the Remote (switching to a momentary display of the fader value in dB when a fader is moved), whereas in DAW Focus mode the top row displays the DAW track names or the CC fader numbers (or user-created labels - see next page).

When Matrix is assigned to a CC layer controlling a MIDI device, the bottom row of the scribble strip displays the V-Pot CC Number or User label (see next page). When a fader or V-Pot is moved, the associated label switches to a momentary display of the value being altered.

The **FLIP** function in the **V-POT MODES** (see Page 84) interchanges the controllers assigned to the Faders and V-Pots as well as the DAW **SEL** switches and V-Sel switches. This makes it possible to have 32 controller channels available to the faders, using the **FLIP** to switch between channels 0-15 and 16-33.

Note that Flip Scribble Strips cannot be used on a CC layer.

Labelling CC Numbers

When a CC layer is active, the display of Controller Numbers in the scribble strip can be replaced with user-created labels which identify the parameters being controlled.

When a CC layer is active in the **DAW** tab and the **Transport/Utility** soft keys are selected, the **CC Scribble Strips** box appears to the left of the saved data **Status** box. Checking this box brings up the **Continuous Control Names** pop-up:



The main part of the pop-up displays a representation of the Matrix digital scribble strip, with the channels' CC numbers displayed in the top row in light yellow and the current label displayed in the bottom row in darker yellow. Clicking on the scribble strip in any channel will allow the channel label to be edited.

Below the scribble strip are four small buttons which switch the scribble strip display between the four sets of CC numbers assigned to the console faders, V-Pots and switches: **Fader**, **V-Pot**, lower **Sel** switch and **V-Sel**. These buttons switch the labelling function between the four CC assignable channel controls and their respective CC number ranges. If you switch ranges without saving your changes, a pop-up will appear inviting you to save the changes before switching ranges.

At the bottom of the window are five larger buttons:

Clear Names leaves the CC labels for that CC range blank. When you press this button, a pop-up appears confirming whether or not you want to continue.

Reset Names returns the scribble strip CC labelling to the CC numbers assigned to the controls. When you press this button, a pop-up appears confirming whether or not you want to continue.

Undo returns the labels for the current CC range to their last saved state. When you press this button, a pop-up appears confirming whether or not you want to continue.

Save saves the labels for the current CC range as part of that layer's configuration.

OK closes the pop-up and returns you to the Remote's **DAW** tab. If you have unsaved changes, a pop-up will appear inviting you to choose between losing your unsaved changes or saving on exit.

This page is intentionally almost blank

Appendices

Appendix A - DAW Protocol Lists

Transport/Utility Function Map

The chart below details the assignments of the transport and utility functions within Pro Tools, Logic and Nuendo/Cubase:

Key Type		Pro Tools	Logic	Nuendo/ Cubase
Transport	RTZ	RTZ	Stop Stop	USB
	END	End	-	-
	LOOP	Loop	Cycle	Cycle
	ONLINE	On-Line	-	USB
	PUNCH	Quick Punch	Drop	Punch
	PREVIOUS	Prev Marker	USB	Previous
	NEXT	Next Marker	USB	Next
	LAST CUE	Last Marker	-	-
	NUDGE -	Kpad -	USB	USB
	NUDGE +	Kpad +	USB	USB
Utility	SHIFT	Shift/All	Shift	Shift
	OPT/ALL	Option/All	Option	-
	CTRL	Control	Control	USB
	⌘/ALT	CMD/Alt/Fine	Alt	USB
	ESC	Fkey 8/Esc	USB	USB
	ENTER	Kpad Enter	Enter	USB
	SAVE	Save	Save	Save
	UNDO	Undo	Undo	Undo
	FOOT 1	Play Foot Switch	Play Foot Switch	Play Foot Switch
	FOOT 2	Record Foot Switch	Record Foot Switch	Record Foot Switch

Note that all USB key commands listed refer to the Logic or Nuendo/Cubase standard command key mappings; see your DAW documentation for more details.

Command soft Key Labelling

The following list details the way in which each DAW protocol command is labelled in the Matrix soft keys. Non-standard commands are asterisked (*):

Pro Tools

Function	Soft Key Label	Function	Soft Key Label
Mix to foreground	Mix	Kpad =	=
Edit to foreground	Edit	Kpad /	/
Open/close transport	Trans	Kpad *	*
Open/Close Mem	Memloc	Kpad -	-
Open/close session setup	Status	Kpad +	+
Open/close plugin editor	Alt	Kpad .	.
Input	Input	Kpad Enter	Enter
Output	Output	Kpad 0	0
Assign	Assign	Kpad 1	1
* Artist Talkback Switch	Artist	Kpad 2	2
Pan	Pan	Kpad 3	3
Mute	Mute	Kpad 4	4
Send A	Send A	Kpad 5	5
Send B	Send B	Kpad 6	6
Send C	Send C	Kpad 7	7
Send D	Send D	Kpad 8	8
Send E	Send E	Kpad 9	9
Bypass	Bypass	Audition	Auditn
Default	Dfault	Audition Pre	AudPre
Undo	Undo	Audition In	AudIn
Control	Ctrl	Audition Out	AudOut
Auto Suspend	AutoS	Audition Post	AudPst
Save	Save	RTZ	RTZ
Auto Enable Plugin	Plugin	End	End
Auto Enable Pan	Pan	On-line	Online
Auto Enable Fader	Fader	Loop	Loop
Auto Enable Send Mute	SMute	Quick Punch	QPunch
Auto Enable Send	Send	Forward	Forwrd
Auto Enable Mute	Mute	Rewind	Rewind
Auto Mode Read	Read	Stop	Stop
Auto Mode Latch	Latch	Play	Play
Auto Mode Trim	Trim	Record	Record
Auto Mode Touch	Touch	* Next Marker	Next
Auto Mode Write	Write	* Prev Marker	Prev
Auto Mode Off	Off	* Last Marker	Last
Option/All	Option	* Reset Marker	Reset
CMD/Alt/Fine	Alt	Edit Capture	Capt
Rec/Rdy all	RecRdy	Edit Seperate	Seper
Shift/All	Shift	Edit Cut	Cut
Edit Tool	EdTool	Edit Copy	Copy
Edit Mode	EdMode	Edit Paste	Paste
Fkey 1	F1	Edit Delete	Delete
Fkey 2	F2	Status Auto	Auto
Fkey 3	F3	Status Monitor	Mon
Fkey 4	F4	Status Phase	Phase
Fkey 5	F5	Status Group	Group
Fkey 6	F6	Group Suspend	Suspend
Fkey 7	F7	Group Create	Create
Fkey 8/Esc	F8	Play Foot Switch	PlayFS
Kpad Clr	Clr	Record Foot Switch	RecFS

Logic

Function	Soft Key Label	Function	Soft Key Label
Track	Track	Touch	Touch
PanSur	PanSur	Latch	Latch
EQ	EQ	Trim	Trim
Send	Send	Save	Save
Plugin	Plugin	Undo	Undo
instr	instr	Group	Group
Flip	Flip	Cancel	Cancel
Global	Global	Enter	Enter
Name/Value	NM/VAL	Marker	Marker
SMPTE/Beats	SMPTE	Nudge	Nudge
F1	F1	Cycle	Cycle
F2	F2	Drop	Drop
F3	F3	Replace	Rplace
F4	F4	Click	Click
F5	F5	Solo	Solo
F6	F6	Forward	Forwrdr
F7	F7	Rewind	Rewind
F8	F8	Stop	Stop
MIDI Tracks	MIDITr	Play	Play
Inputs	Inputs	Record	Record
Audio Tracks	AudTr	VSel 1	VSel 1
Audio Instruments	AudIns	VSel 2	VSel 2
Aux	Aux	VSel 3	VSel 3
Busses	Busses	VSel 4	VSel 4
Outputs	Outpts	VSel 5	VSel 5
User	User	VSel 6	VSel 6
Shift	Shift	VSel 7	VSel 7
Option	Option	VSel 8	VSel 8
Control	Ctrl	Play Foot Switch	PlayFS
Alt	Alt	Record Foot Switch	RecFS
Read	Read	* Artist Talkback Switch	Artist
Write	Write		

Nuendo

Function	Soft Key Label	Function	Soft Key Label
Page Down	PageDn	Save	Save
Pan	Pan	Revert	Revert
EQ	EQ	Read	Read
Page Up	PageUp	Write	Write
Inserts	Insert	Project	Prject
FX Sends	FXSend	Mixer	Mixer
Flip	Flip	Sends	Sends
Edit	Edit	Instruments	Instrm
Name/Value	Nm/Val	Master	Master
SMPTE/Beats	SMPTE	Motors	Motors
F1	F1	Solo Defeat	SolDef
F2	F2	Shift	Shift
F3	F3	Left	Left
F4	F4	Right	Right
F5	F5	Cycle	Cycle
F6	F6	Punch	Punch
F7	F7	Previous	Prev
F8	F8	Add	Add
Fader Group 1	FadGp1	Next	Next
Fader Group 2	FadGp2	Forward	Forwrđ
Fader Group 3	FadGp3	Rewind	Rewind
Fader Group 4	FadGp4	Stop	Stop
Fader Group 5	FadGp5	Play	Play
Fader Group 6	FadGp6	Record	Record
Fader Group 7	FadGp7	Play Foot Switch	PlayFS
Fader Group 8	FadGp8	Record Foot Switch	RecFS
Undo	Undo	* Artist Talkback Switch	Artist
Redo	Redo		

Appendix B - Technical Specifications

Performance Figures

Headroom < +26dBu @ 1kHz (< 1% THD)

Line In to Direct Out

Frequency Response ± 0 dB at 20Hz, +0/-0.1dB at 20kHz, -1dB at 80kHz

Noise < -89dBu 20Hz - 22kHz

THD < 0.002% @ 1kHz (+24dBu, 22kHz filter)

Line to Aux Bus Out

Frequency Response ± 0 dB at 20Hz, +0/-0.1dB at 20kHz

Noise < -93dBu (no channels routed)

< -76dBu (all channels routed, faders at 0dB)

THD < 0.002% @ 1kHz (+24dBu, 22kHz filter)

Line To Mix/Rec Bus Out

Frequency Response ± 0 dB at 20Hz, +0/-0.1dB at 20kHz

Noise < -89dBu (no channels routed)

< -77.5dBu (all channels routed, faders at 0dB, pan at centre)

THD < 0.002% @ 1kHz (+24dBu, 22kHz filter)

Matrix Console			
Parameter	Value	Unit	Notes
Width	946	mm	
Height	228	mm	<i>including feet</i>
Depth	724	mm	<i>excluding connectors</i>
Weight	25	kg	
Heat Dissipation	130	W	<i>approximately</i>
Noise	-	-	<i>fanless</i>
Connector (DC power input)	BICC 12-pin Male		

Matrix Power Supply			
Parameter	Value	Unit	Notes
Width	106	mm	
Height	202	mm	<i>including feet</i>
Depth	306	mm	<i>excluding lead and connectors</i>
Weight	5	kg	
Heat Dissipation	45	W	<i>approximately</i>
Noise	-	-	<i>fanless</i>
Voltage	100 - 240	V	$\pm 10\%$
Current	2.0 - 1.0	A	
Connector (mains input)	IEC320 10A Male		

Matrix Digital IO Specifications

Test conditions (unless otherwise specified): Input test signal is a 1kHz sine wave; measurement bandwidth is 22Hz to 22kHz, signal level is -1dB FS.

Stereo ADC

Source selectable between Mix bus, Record bus and Monitor (pre level control) signals.

Connections: S/PDIF (TosLink optical) and AES-3 (male XLR). Signal available on both connectors at all times.

Sample rate - locks to selected digital input up to a maximum sample rate of 192kHz. In the absence of a valid digital input defaults to 48kHz.

Dynamic range typically 113dB A-weighted, 111dB unweighted. Worst case 108dB unweighted

THD < 0.0015%

0dB FS switchable between +18dBu and +24dBu

DAC

Connections: source selectable from Matrix front panel between S/PDIF (TosLink optical) and AES-3 (female XLR) inputs.

Sample rate 32kHz to 192kHz

Dynamic range typically 116dB A-weighted, 111dB unweighted. Worst case 109dB unweighted

THD < 0.001%

0dBFS switchable between +18dBu and +24dBu

Matrix Tabletop cutout

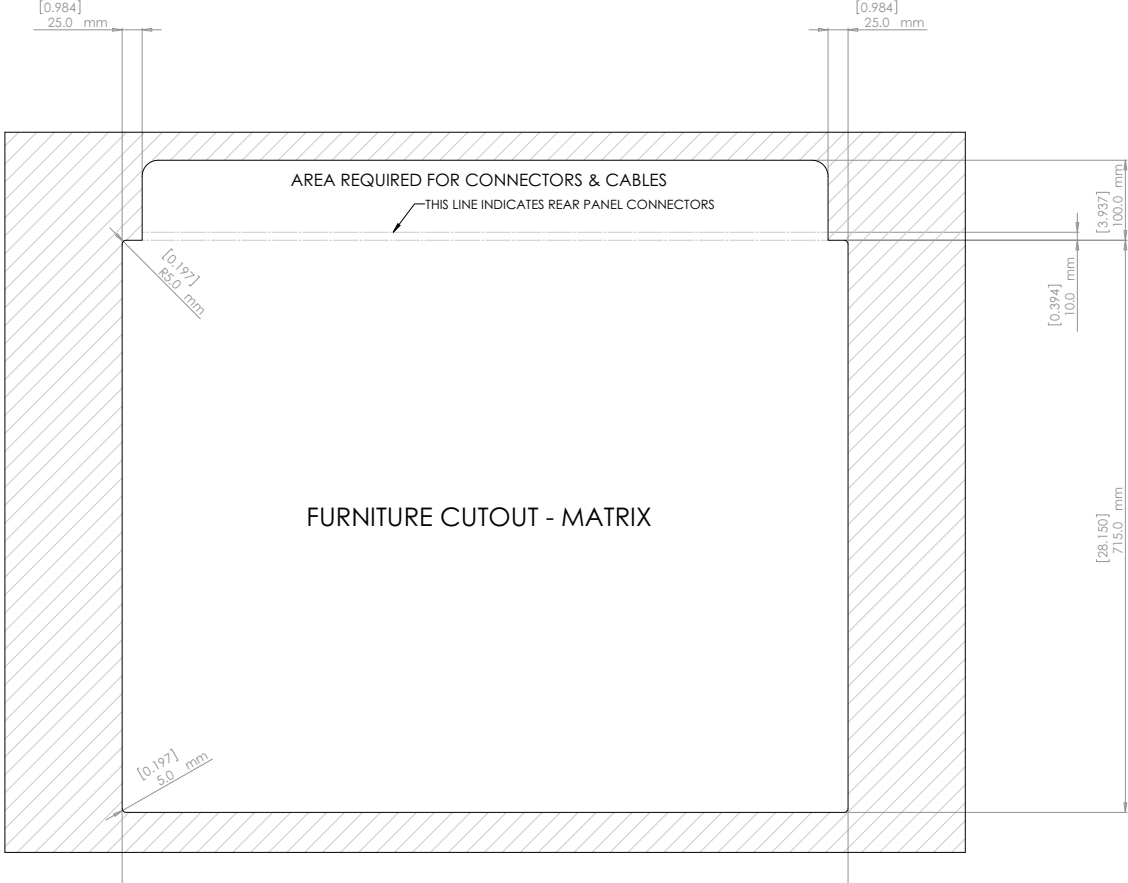

Dimensions: [i n c h e s]
millimeters

Please note that Matrix is not designed to be hung when set in furniture. The Matrix chassis must always be supported from the base with a shelf or an alternative mechanical fixing.

This page is intentionally almost blank

Appendix C - Audio Connectors and Pinouts

XLR 3-Pin

Pinout for balanced analogue audio (Mini LS):

Pin 1	-	Screen/Ground
Pin 2	-	Hot (+ve)
Pin 3	-	Cold (-ve)

Pinout for balanced digital audio (AES3):

Pin 1	-	Screen
Pin 2	-	Hot (+ve)
Pin 3	-	Cold (-ve)

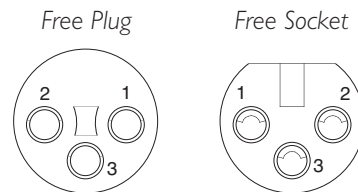

Connectors Viewed
From Wiring Side

D-Type Multipin

25-way

Dimensions: 55 x 15mm (approx.)
Cable Dia: 8mm (typical)

Connectors Viewed From Wiring Side

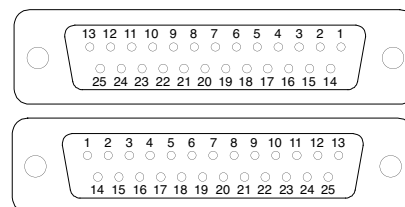

Plug

Socket

9-way

Dimensions: 35 x 15mm (approx.)
Cable Dia: 7mm (typical)

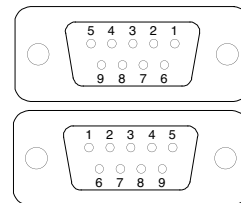

Plug

Socket

1/4" Jack

Pinout for headphone:

Tip	Right channel
Ring	Left channel
Sleeve	Ground

Pinout for footswitch:

Tip	Control input (connect to 0V to activate)
Ring	n/c
Sleeve	0V

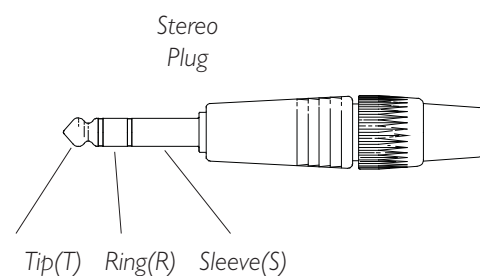

Stereo
Plug

Tip(T) Ring(R) Sleeve(S)

Matrix 25-way D pinouts							
Location:		Matrix rear panel					
Connector Type:		25-way D-type female					
Circuit	hot	cold	screen	Channels 1-8, 9-16	Ext 1, 2	Mon LS Artist out	Rec, Mix F/Mon
1	24	12	25	Channel 1 (9)	Ext 1 Input L	Mon Out L	Rec Out L
2	10	23	11	Channel 2 (10)	Ext 1 Input R	Mon Out R	Rec Out R
3	21	9	22	Channel 3 (11)	Ext 2 Input L	Mini Out L	Mix Out L
4	7	20	8	Channel 4 (12)	Ext 2 Input R	Mini Out R	Mix Out R
5	18	6	19	Channel 5 (13)	-	Artist Out L	Follow Mon Out L
6	4	17	5	Channel 6 (14)	-	Artist Out R	Follow Mon Out R
7	15	3	16	Channel 7 (15)	-	-	-
8	1	14	2	Channel 8 (16)	-	-	-

Matrix 25-way D pinouts							
Location:		Matrix rear panel					
Connector Type:		25-way D-type female					
Circuit	hot	cold	screen	Rec, Mix, Cue Send	Rec, Mix, Cue Rtn	Cue St, FXI-4 Snd	FXI-4 Rtn
1	24	12	25	Rec Send L	Rec Return L	Cue Out L	FX return 1L
2	10	23	11	Rec Send R	Rec Return R	Cue Out R	FX return 1R
3	21	9	22	Mix Send L	Mix Return L	FX 1 Out	FX return 2L
4	7	20	8	Mix Send R	Mix Return R	FX 2 Out	FX return 2R
5	18	6	19	Cue Send L	Cue Return L	FX 3 Out	FX return 3L
6	4	17	5	Cue Send R	Cue Return R	FX 4 Out	FX return 3R
7	15	3	16	-	-	-	FX return 4L
8	1	14	2	-	-	-	FX return 4R

Surround Monitor Card 25-way D pinouts					
Location:		Matrix rear panel			
Connector Type:		25-way D-type female			
Circuit	hot	cold	screen	EXT 1,2	MON, MINI
1	24	12	25	EXT 1 C	MON out C
2	10	23	11	EXT 1 LFE	MON out LFE
3	21	9	22	EXT 1 LS	MON out LS
4	7	20	8	EXT 1 RS	MON out RS
5	18	6	19	EXT 2 C	MINI out C
6	4	17	5	EXT 2 LFE	MINI out LFE
7	15	3	16	EXT 2 LS	MINI out LS
8	1	14	2	EXT 2 RS	MINI out RS

X-Rack / Diag		
Location:		Matrix rear panel
Connector Type:		9-way D-type female
Pin	Description	Notes
1	-	
6	-	
2	<i>Tx Data</i>	<i>X-Rack data out</i>
7	<i>(Tx Data)</i>	<i>(diagnostic terminal data out)</i>
3	<i>Rx Data</i>	<i>X-Rack data in</i>
8	-	
4	<i>(Rx Data)</i>	<i>(diagnostic terminal data in)</i>
9	-	
5	0V	<i>data ground</i>

Appendix D - Environmental Specification

Temperature

Operating:	5 to 30 Deg. C
Non-operating:	-20 to 50 Deg. C
Max. Gradient:	15 Deg. C/Hour

Relative Humidity

Operating:	20 to 80%
Non-operating:	5 to 90%
Max. wet bulb:	29 Deg. C (non-condensing)

Vibration

Operating:	< 0.2G (3 - 100Hz.)
Non-operating, power off:	< 0.4G (3 - 100Hz.)

Shock

Operating:	< 2G (10mSec. Max.)
Non-operating:	< 10G (10mSec. Max.)

Altitude (above sea level)

Operating:	0 to 3000m
Non-operating:	0 to 12000m

This page is intentionally almost blank

Appendix E - Software Updates

Software downloads for both the Matrix console and Matrix Remote are available from our website:

www.solidstatelogic.com/support/consoles/matrix/downloads.asp

We recommend that the console and remote software versions be kept in sync with one another.

Remote Software Updates

To update the Matrix Remote software, delete the old version and install the new version following the installation instructions in Chapter 1.

Note: Because all Matrix data is saved on the SD card on the console, not as part of the Matrix Remote, the Remote can be deleted without any loss of data

Console Software Updates



Matrix console software updates are named MatrixUpdate followed by the software version. Download the Matrix update file to the computer hosting the Matrix Remote and double click on it to bring up the Matrix Update pop-up.

Click on **Find** to open the **Find Matrix** pop-up and scan for consoles to update. Once the console(s) on the network have been found, highlight the console you wish to update and click **Select** to close the pop-up.



Click **Send** and the software will now be sent to the console. When the send is complete, click on **Save** to save the new software. Once the save is complete, you will need to restart the console.

It is very important that the console does not lose power during the save.

Software Rescue Disk

In the unlikely event that the on-board flash memory fails, or you suffer a power failure while updating software, Matrix can boot up from the SD card in the back of the console:

Download the latest Matrix update file. This is a Java (.jar) file. Change the suffix to .zip and use a zip program to open the file and extract the code.img file to an SD card (you will need an SD card reader).

Turn off the console, fit the SD card, and reboot. The console will now restart (a little slower than normal) from the SD card.

Finally, repeat the software update process.

This page is intentionally almost blank

Appendix F - Matrix Support

Our Commitment to Customer Support

A great product is only the start of what sets SSL equipment apart. We believe that the world's best products demand the best support. To provide this, SSL has a network of sales and service centres throughout the world, including its subsidiaries in New York, Los Angeles and Tokyo. Through these offices, and appointed distributors in other countries, a full program of backup and technical support is guaranteed.

Introduction

Matrix has been designed to require a minimal amount of user calibration or adjustment and requires no regular maintenance. In the unlikely event that you experience a technical problem, the quickest way to resolve the issue is for your local distributor to arrange a replacement part for you to fit.

The modular design of Matrix's hardware allows assemblies to be replaced with the minimum amount of technical experience. The maintenance section of this manual provides detailed instructions on replacing assemblies in the console.

Solid State Logic and selected distributors also offer a console repair service for both in and out of warranty repairs.

Support

Matrix Registration

We recommend that you register your Matrix console online, using the link below. Registering is free and ensures that you have access to SSL Technical Support via our on-line knowledgebase, software downloads from our website, and will also provide you with automatic email notifications regarding product updates:

www.solidstatelogic.com/productregistration

On-line support

To access the latest support information on Matrix, please visit our online support site. Answers to common questions are kept up to date by our support staff to ensure that answers are relevant, accurate and comprehensive. This resource is available to you 24 hours a day, 7 days a week:

www.solidstatelogic.com/support/consoles/matrix

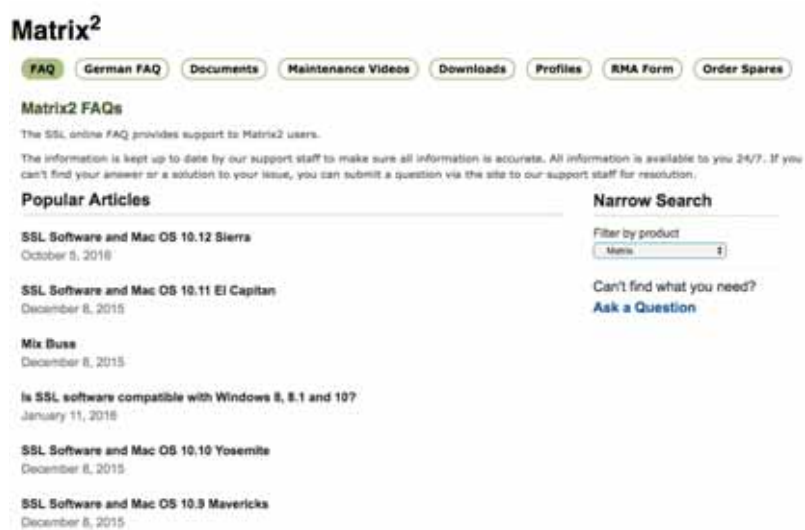

If you cannot find an answer to your question or a solution to your issue, you can submit your query to our support teams.

Software downloads and additional documentation is also available from our website:

www.solidstatelogic.com/support/consoles/matrix/downloads.asp

See Appendix E for instructions regarding updating software.

Service Centres

In addition to the on-line services, you can locate and contact your local distributor via the link below:

www.solidstatelogic.com/contact

Warranties

Factory Warranty

The Factory Warranty covers the repair of defects in materials and workmanship during the warranty period.

Pursuant to the Solid State Logic Terms and Conditions, under European consumer law, the purchaser has full statutory warranty rights for two years from the date of delivery of the product. The warranty is valid only in those Member States of the European Union (EU), who have adopted the applicable EU law into their national legislation, otherwise a warranty term of one year will apply. The applicable national legislation governing the sale of consumer goods is not affected by this warranty. Warranty claims will only be accepted if the purchased product has been used for its intended purpose. Any purchased product used for an unintended purpose will not be eligible for warranty protection. Consumable items, accidental damage and damage caused by operation of the equipment outside of Solid State Logic's recommended operating conditions are not covered by this warranty.

For all warranty enquiries or claims please address the claim to the dealer from which you purchased the product, within a period of one month from the date on which you detected its lack of conformity with the terms of the warranty. Please include your original proof of purchase when initiating the claim.

The distributor will be able to arrange for a replacement assembly to be supplied or for the console to be repaired at their local office or at Solid State Logic.

Please note that we cannot provide a substitute or temporary loan Matrix console during the repair period.

Manufacturer backed Extended Warranty

Give yourself even greater peace of mind. When you buy a console, you have the right to peace of mind. Purchasing a Manufacturer backed Extended Warranty will help you maintain that sense of security for years to come.

An extended warranty provides you with great cover and the ability to budget operating costs accurately. Extended warranties are available from the end of the Factory Warranty period until the console is five years old.

The warranty provides your console with cover for parts and repairs. Should you experience an issue during the extended warranty period we can dispatch a replacement assembly to you or you can return your console to the distributor who supplied the warranty or to SSL for repair. All parts and labour involved in the repair will be free of charge. Please note that the extended warranty excludes all shipping costs and that we cannot provide a substitute or temporary loan Matrix console during the repair period.

You can purchase an extended warranty at any time during the product's initial Factory or Extended Warranty period. You can choose to extend for 12, 24, 36 or 48 months. Longer commitments attract special discounts.

If your Factory Warranty has expired or your existing Extended Warranty has lapsed, you can still purchase an extended warranty. However, you will not be entitled to the benefits of the extended warranty for a period of 30 days from the purchase date of the extended warranty. After 30 days your 12, 36 or 48 month warranty will commence.

If you would like to purchase an extended warranty for your console, please contact your local distributor or nearest SSL office.

Repair

Spare Parts

As you would expect, SSL offers a full range of spare assemblies for Matrix.

In addition, SSL offers an exchange service for the high value assemblies. The exchange service reduces the cost of replacing the more expensive assemblies. With the Exchange Service we simply ship you a replacement assembly and you return your faulty unit to SSL.

Subject to operating hours of local couriers, SSL will dispatch replacement assemblies on the same day from the 'Critical Spares Inventory' held at strategic world-wide locations.

Console Repair Service

SSL and selected distributors offer a repair service for your console. If your console develops a fault you can return your console for repair.

Shipping

During the Factory Warranty period SSL will pay carriage costs for shipments to your facility. You are responsible for all carriage and insurance costs for the return of the faulty item.

Out of warranty and during any applicable Extended Warranty period, SSL will recharge carriage costs for all assemblies and repaired console shipments to your facility. You are responsible for all carriage and insurance costs for the return of the faulty assembly or console to SSL.

Returned goods must be suitably packed in order to avoid damage in transit. We recommend that all packaging is retained in case you need to return or transport Matrix in the future. The packaging has been purposely designed to ensure that Matrix is adequately protected. Solid State Logic cannot accept responsibility for any damage caused in transit as a result of insufficient packaging. Regardless of warranty status, Solid State Logic will charge for replacement packaging.

SSL strongly recommend that you arrange adequate insurance cover for return parts shipments, as SSL cannot be held responsible for return goods that sustain damage in transit.

Appendix G - Maintenance



These servicing instructions are for use by qualified service personnel only. To reduce the risk of electric shock do not perform any service unless you are qualified to do so.



Disconnect all power cords before removing any panels or modules.

Introduction

Matrix has been designed to require a minimal amount of user calibration or adjustment and requires no regular maintenance routine. Additionally, there are no links or switches to configure the operation of the console. In the unlikely event that you experience a technical problem this section of the manual will guide you through the identification and replacement of the defective module.

Matrix contains a mix of analogue and digital assemblies, all of which use SMT (Surface Mount Technology) extensively making field repair to component level unrealistic. This means that repair of the console will be, primarily, by on-site board exchange.

Should you require further assistance with a problem please contact your local SSL distributor or use the on-line help facility on our website:

www.solidstatelogic.com/support/soles/matrix

Replacing or Reseating the SD Card.

Should you need to replace or reseat the SD card, insert the card and re-boot the system. New cards will be initialised with the default Profiles as well as a Project containing one Title.

Note that the initialisation process significantly increases Matrix's re-boot time.

Part Numbers, Revision Levels etc.

Within this manual are details of adjustments which may be dependent upon the revision of each particular assembly. Therefore a brief discussion on part numbers, revision levels etc. is in order.

Solid State Logic's manufacturing facilities, in common with all manufacturing companies, work with part numbers. If a part does not have a part number, it simply does not exist! All SSL assemblies therefore will have a part number and all assemblies will have a small white oblong label somewhere with that part number printed on it. This label should look something like this:

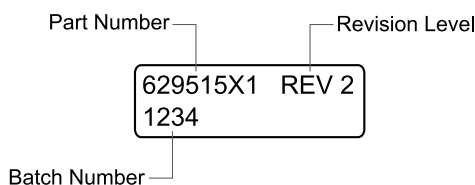

Part Number

All SSL assemblies (and in fact all components and items) have a unique part number. Sub assembly part numbers are generally 8 digits long (metalwork, drawings and documents can be 11 or 12 digits; the additional digits relate to revision level). Matrix assembly numbers would typically be as shown:

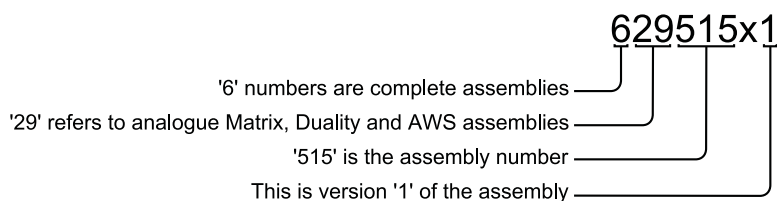

Revision Level

The way that any assembly is built is controlled by the Revision Level. This is a decimal number which will increment every time something about the build of an assembly changes; component value changes, firmware changes etc. are all changes that would trigger a revision change. Wherever reference is made to 'Assembly Revision', it is the revision level on these partcode labels that is being referred to.

Batch Number

SSL manufactures most assemblies in batches, which can range in size from 2 to 100 or more. Each time a set of assemblies is manufactured the assemblies in that production run are given a unique batch number. This batch number allows SSL to track the movement and history of all assemblies it manufactures.

Diagnosing Faults

It is always sensible to check external equipment first (unless the fault is obviously within the console - such as a faulty pot or switch). Matrix spends the majority of its life in a stationary position, whereas microphones, their cables and effects devices etc. are constantly on the move, and hence are much more likely to incur damage.

Once you have established that the problem lies within the console, you need to determine whether the problem is due to an operational error, or hardware failure. The most common, and easiest to solve, problems are operational errors, and you should eliminate these first. Refer to the relevant section in this manual, and ensure that you have followed the correct procedure.

If you have confirmed that the problem is neither due to external equipment or operational error, then you possibly have a hardware fault. In most cases, a fault can be located in minutes, with little technical knowledge. However, ensure that you read the paragraphs on Replacing Modules later in this section before attempting any maintenance.

The key to correctly diagnosing a hardware fault is to understand the console's signal flow. Block diagrams detailing audio signal flow, digital control bus structure and power wiring, can be found at the end of this section.

Hardware faults can be defined as one of three types: Audio, Control, or Power.

Audio Faults

Audio faults will most likely manifest themselves as either partial or total signal loss, or distortion of the audio signal.

Referring to the Matrix Hardware Signal Flow Block Diagrams, you can see that there are many possible signal paths through the console. Logical routing, and monitoring of signals at different points, will enable you to easily locate the faulty module.

To give an example of an audio fault, examine the following problem. By working through this example you will see the basic principles of fault finding at work.

You have several channels, all centre panned, routed to the REC bus. When monitoring the Rec Bus you notice that the audio can only be heard on the left main and mini monitor outputs. Once you confirmed the external connection to the console your first step is to refer to the Matrix Hardware Signal Flow Block Schematic. From this you will see that channel strips output passes through several stages of hardware before reaching the monitors.

We can start to isolate the problem by checking the signal path halfway through the chain.

Looking at sheet 2 of the signal flow diagram we can see that the audio source for the monitors is selected on the 629515 assembly. Route an alternative stereo source to the monitors, such as EXT 1.

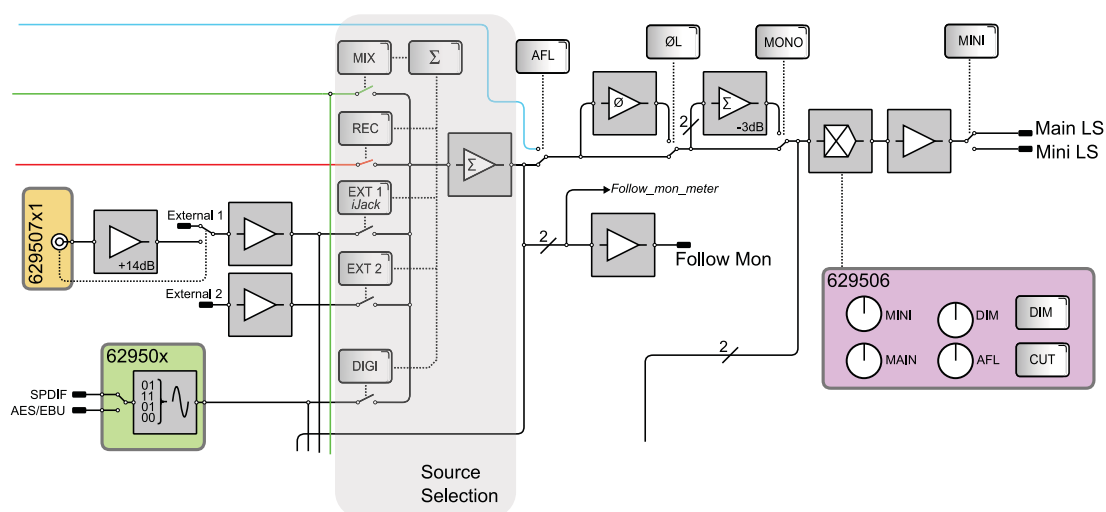

Can you hear audio on left and right monitors? If you can still only hear audio on the left main and mini monitors then the problem must be post the source selection and as you can see from the diagram must be a problem on the 629515 assembly.

For the sake of this example we will assume that when you switched to an alternative source you could hear audio on both left and right monitors indicating that the problem is prior to the monitor source selection. Using the same principle we will try to isolate the signal path further. Again referring to the Matrix block schematic sheet 2 you can see that the REC bus feed to the monitoring is taken from the 629508 assembly which is shaded blue on the left hand side of the diagram. Audio from the channels on the REC bus are summed together by this module. The summed audio is then routed to several destinations including the REC bus insert send.

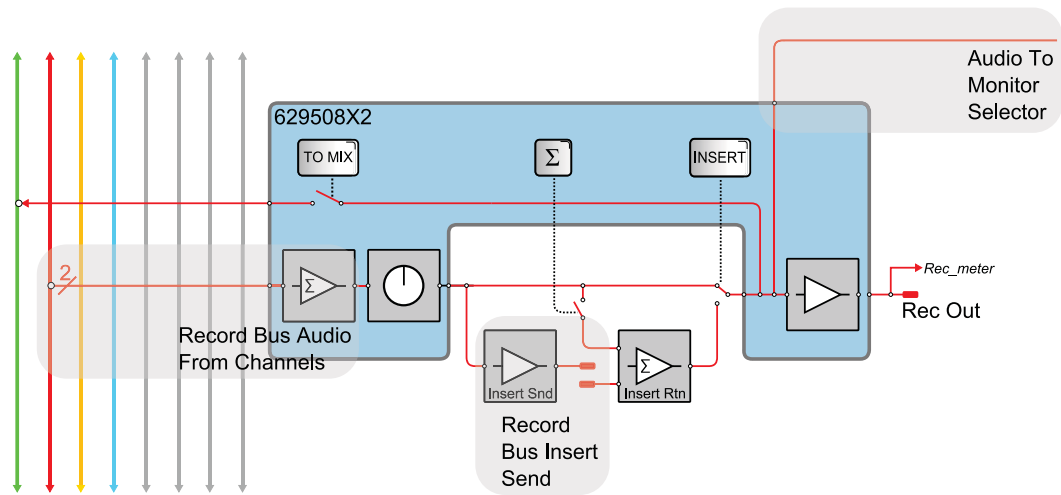

Choosing a piece of external equipment which has an input meter, switch the REC bus insert into the signal path. Check the input meter on the inserted equipment. Can you see signal on both inputs or just the left input? If you can only see signal on the left channel then it is most likely that the fault lies with the 629508 REC bus assembly.

Again, for the sake of this example, we will assume you can see signal on both inputs. Select the REC bus as the monitor source. If you can now hear audio on both monitors then the fault is most likely with the switching of the insert return on the 629515 assembly. If you still can only hear audio on the left monitor then the problem is most likely with the 629508.

As you can see in a matter of minutes we have broken down the signal path and identified the faulty module. The next step would be to follow the module removal instructions later in this section and re-seat the suspected module in its slot to ensure that a valid connection is made. Once re-seated, test the signal path again. If there is no change, a replacement will be required.

Control Faults

Control faults will typically result in either the corruption of display information, or the failure of encoders and switches. The majority of the console's display and control functions are performed by the 629505XI CPU, which is located behind the centre section meter panel. The CPU uses several serial data busses to carry control data, such as fader position data and switch presses, to the CPU as well as display data, such as LED illumination commands, to the displays and motor drive information to the faders.

Referring to the Matrix Control Block Schematic you will see that there are four Digital Data bus connections to the CPU:

The first, labeled 'Router', is daisy chained through the right hand 626516XI assembly into the left hand assembly and controls the routing matrix.

The second, labeled 'Tile-control', daisy chains through the 629506XI into the 626507XI, back into the 629506XI and then through the two 629502XA solo and cut panels. This data chain carries switch presses and rotary encoder data to the CPU and corresponding LED and display data back from the CPU. Additionally this data chain also carries channel strip TR object data which is converted from analogue to digital position data on the 629502XA assemblies.

The third connection, labeled 'Channels', connects the 629515XI and 629511XI assemblies to the CPU using a 'Y' split cable and then daisy chains through the 629511XI to the two 629510XI assemblies. This third connection also carries switch press data from the analogue modules and LED data from the CPU. This connection also carries a separate MDAC (Multiplying Digital to Analogue Converter) control bus which writes gain data to the channel and centre section MDAC elements.

Finally the fourth connection, labeled 'meters', daisy chains through the three meter assemblies driving the LED bar graph displays.

All of these data chains are 'point to point' connections and as such if any one of the assemblies fails or is removed then the flow of data will be interrupted and assemblies after that point in the chain will fail to function.

The following example highlights a data bus fault and explains how the fault might be located.

After powering on the console you notice that the data displays for channels 1 to 8 are blank and the corresponding solo and cut switches work but do not illuminate.

Once again refer to the Matrix Control Block Schematic. From the diagram you can see that data bus for the left 629502XA assembly is connected to socket labeled 'out' on the right 629502XA assembly and the power is supplied from the left hand 629516XI routing assembly. From the fault description we know that the data from the switches is reaching the CPU so the power to the assembly must be good so we can rule this out.

We know that the display data is reaching the right hand 629502XA assembly as the displays and LEDs are functioning correctly. From this we can conclude that the problem must be with either the output of the right assembly or the input of the left 629502XA assembly. This leaves three potential causes. The first is that the data ribbon connection between the two panels is not seated correctly. The second is that the input stage to left hand 629502XA assembly is faulty. The third is that the right hand panel has a faulty output stage.

To eliminate the first possibility, power down the console and gain access to the PCB side of the 629502XA assemblies (refer to Replacing Modules information at the end of this section). Remove and then reinsert the 34 way ribbon connector between the two 629502XA assemblies to ensure that a sound connection is made. Re-assemble the console and check the condition of the fault. For the sake of the example we will assume that this did not resolve the problem.

The next possibility to eliminate is that one of the 629502XA Panels is faulty. Power down the console and swap the two assemblies. Re-power the console. If the panel originally in the left hand position was faulty, then neither panel will now function. In this case you should revert to the original configuration and replace the faulty panel. If, however, the problem was due to the failure of right hand panel's output stage, then you should find that both assemblies are now functioning correctly. As the left hand panel is not required to buffer data onto another panel, this fault will not effect the operation of the console and can be left in this position allowing you to continue working unhindered.

Power Faults

The console's power supply is externally housed and consists of a single SMPS (Switch Mode Power Supply) providing all of the console's analogue and digital power rails.

Power from the external supply is wired via the twist-lock connector on the rear of the console to the 629515XI and two 629516XI assemblies. It is then distributed to all the other assemblies through either a dedicated power loom or as part of a data ribbon power connection. The 629515XI and 629516XI assemblies use resettable fuses to protect and isolate their power rails from the main supply. The console's 629505XI CPU is powered directly from the SMPS and is again protected with PTC thermistors on the CPU assembly.

The SMPS is fitted with a protection fuse, however, this is not a user serviceable part. If this fuse fails there has been a severe power supply fault and the whole unit must be replaced.



The Matrix external power supply contains no user serviceable parts. Do not attempt any maintenance.

Replacing Assemblies



Removal of modules while power is applied to the console will almost certainly result in component failure.



Refer to the Matrix Wiring Diagram at the end of this section when reconnecting wiring looms. Incorrect connection may result in damage to one or more assemblies.



All of the screws used in Matrix are 5mm pan Pozi - do not replace with screws of any other length. Doing so could potentially cause damage to front panel or remove the threaded insert from the trim.

Once you have identified the location of the fault and have taken delivery of a replacement assembly, you are in a position to replace the faulty part.

Access to all of Matrix's assemblies is from the underside of the console and as such will require the console to be placed face down, however, please read the instructions for the part to be removed fully before starting work as some assemblies require the removal of front panel knob caps and collars before the console is turned over.

Tools

The following tools are supplied with Matrix and will enable you to replace the majority of assemblies:

Description

No. 1 Pozidrive screwdriver

Knob fixing tool 15mm

Allen key 2mm

SSL Part No.

80C2CEHC

80C66G9C

80CLC6A5



All screws used in the assembly of Matrix are Pozidrive screws, although similar in appearance to other cross head screws, the use of a non Pozidrive screwdriver will damage the screw head, potentially making future removal almost impossible.

You may also find that the following tools, which are not supplied with Matrix, or their equivalent, make the removal process simpler:

Description

5.5mm nut spinner

6BA nut spinner (VU meters only)

SSL Part No.

80C4DHHC

80C4BCHC

1 - Base Plate Removal

- Remove all external connections to the console.
- Place the console face down on a protective surface.
- Using a #1 Pozidrive screwdriver, remove the 33 pan head Pozi screws from the large base plate, including the four central screws.
- Remove the baseplate.

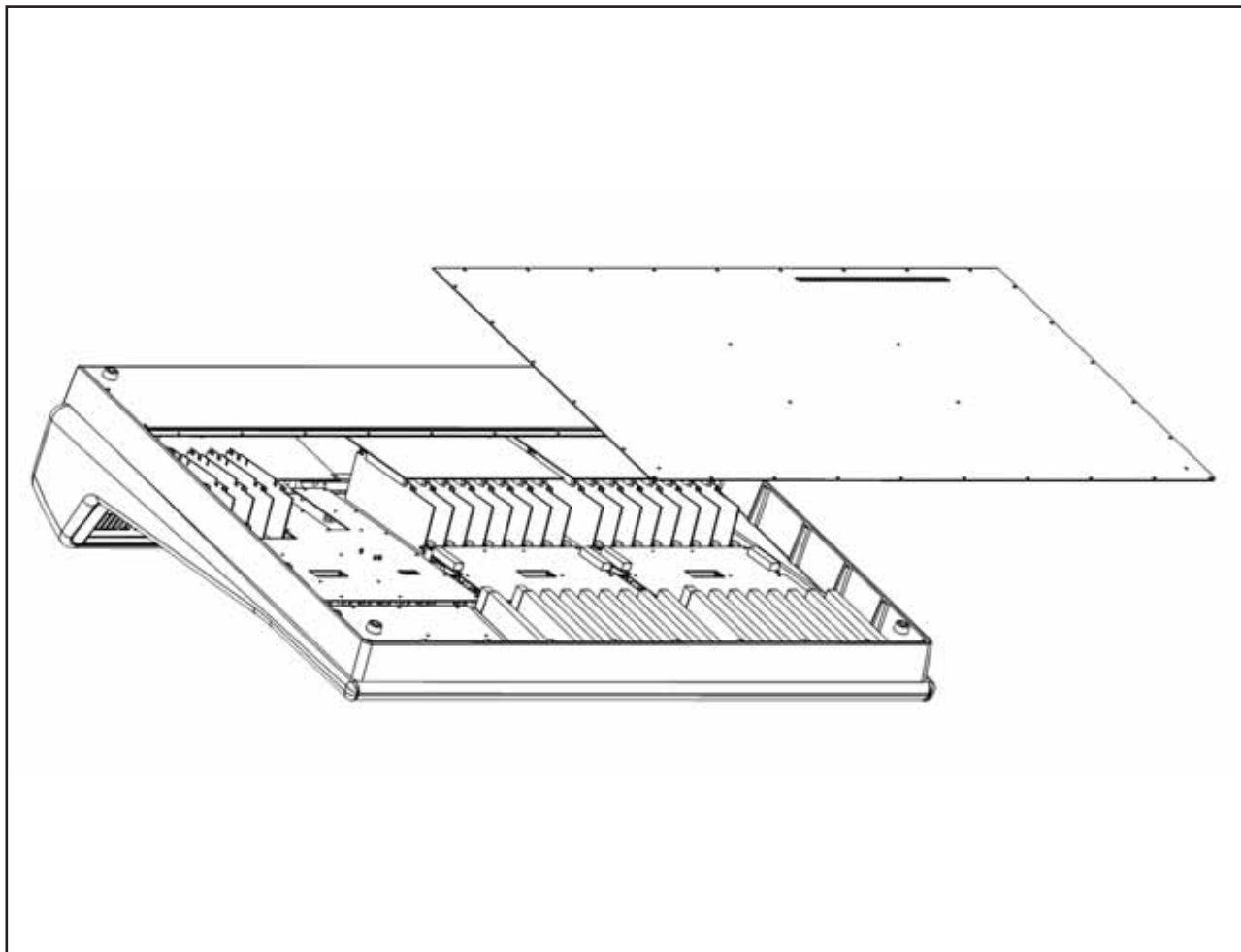

2 - Rear Connector Panel Removal

- Either follow instruction #1 for full base plate removal or just remove the back row of base plate screws to leave the base plate in place (all of the following illustrations show the base plate removed, regardless of whether it is essential to access the assemblies concerned).
- Using a #1 Pozidrive screwdriver, remove the 19 pan head Pozi screws from the edge of the rear panel.
- Slide the panel away from the console slightly and then rotate the panel so that the connectors lay against the underside of the console.
- Align the holes in the rear panel with the inserts on the base of the console and secure in place with two of the previously removed pan head screws.

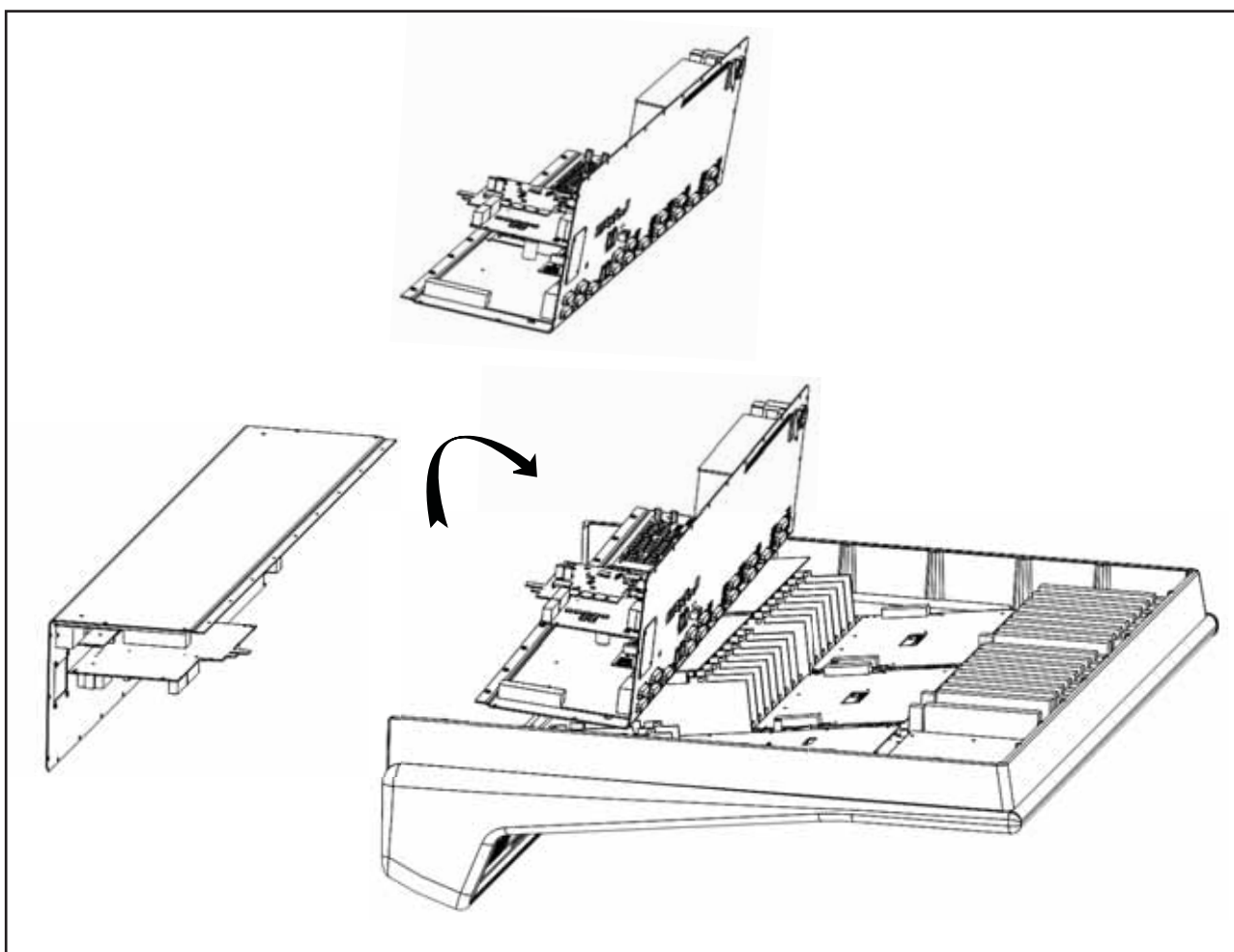

3 - 629940XC Fader Replacement

- Remove fader knob cap from the fader to be replaced.
- Loosen but do not remove the two hex screws located at the top and bottom of the fader on the front panel.
- Follow instruction #1 for base plate removal.
- Unplug the two connectors from the fader to the 629502XA assembly.
- Slide the front of the console over the edge of the work surface to gain access to the faders.
- Remove the two loosened hex screws and remove the fader from the console.
- Fit the replacement part, ensure correct orientation and secure with the two hex screws.
- Connect the fader to the 629502XA assembly, refer to adjacent faders for correct connector order .
- Refit the back panel and rotate the console face upwards.
- Finally, fit the knob cap and test for correct operation.
- No user calibration of the fader is required.

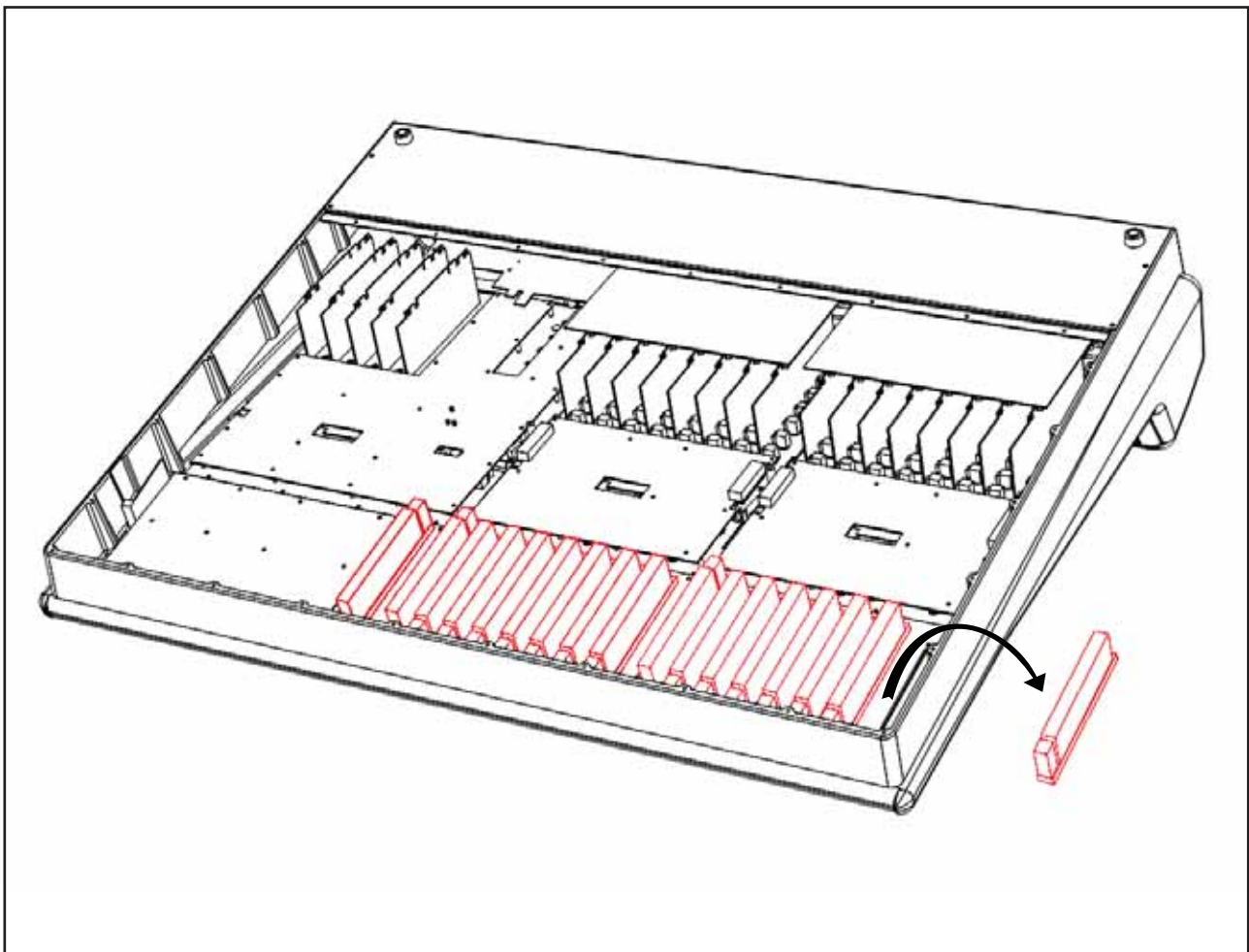

4 - 629502XA Solo and Cuts Panel Replacement

- There are two 629502XA assemblies in the Matrix console, one for channels 1-8 the second for channels 9-16. Remove the knobs caps from the assembly to be removed.
- Follow instruction #1 for the base plate removal.
- Using a #1 Pozidrive screwdriver, remove the 12 black pan head screws from the 629502XA assembly and lift the assembly clear of the console.
- Unplug the eight fader and motor connections and the external ribbon cables from the 629502XA.
- Fit new assembly and secure in place.
- Reconnect all cables, refer to the wiring diagram in at the end of this section for further details.
- Refit the back panel, rotate the console and replace and knob caps.

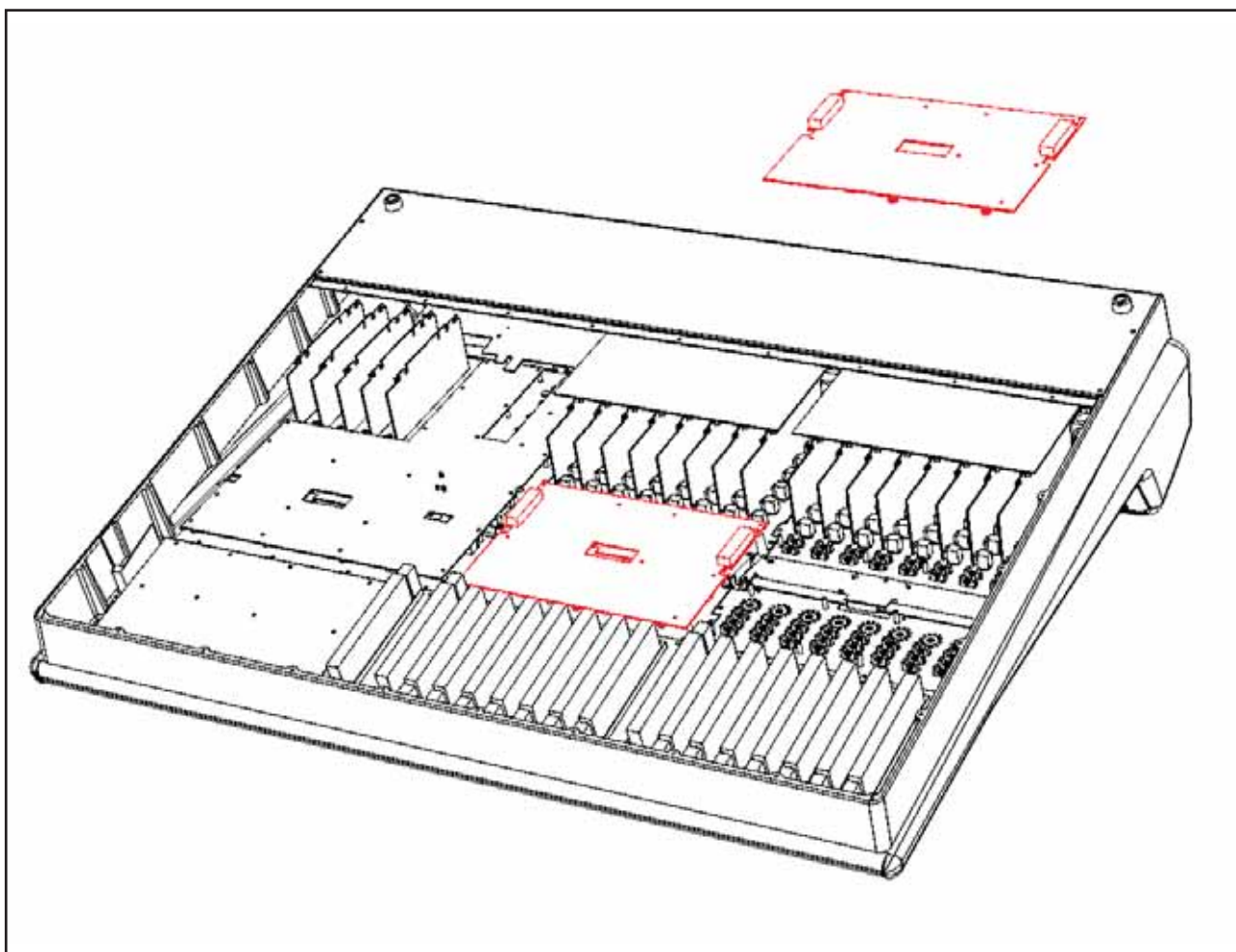

5 - 629506XB Monitor Tile Replacement

- Remove the master fader V-pot knob cap.
- Follow instructions #1 and #2 for base plate and rear panel removal.
- Disconnect all ribbon cable connections to the assembly.
- Remove all pan Pozi screws.
- Replace with new assembly, reassemble and test for correct operation.

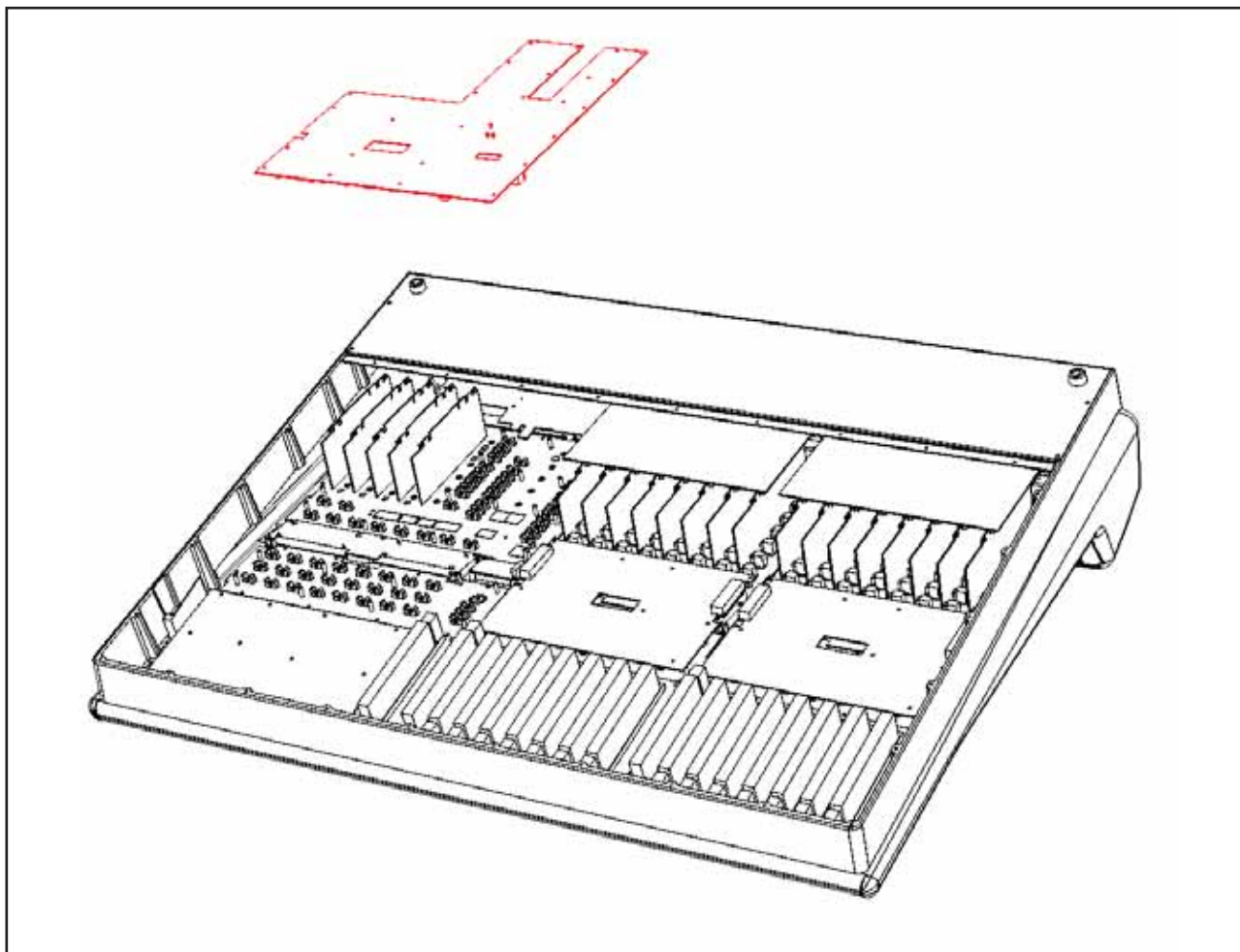

6 - 41HJYLC₃ Channel LCD Replacement

- Follow instruction #4 for 629502XA removal to reveal the display.
- Remove the three pan Pozi screws and remove the assembly.
- Fit new assembly and screw in place.
- Reassemble and test for correct operation.

7 - 41HJYLC₃ Centre Section LCD Replacement

- Follow instruction #4 for 629506XA removal to reveal the display.
- Remove the three pan Pozi screws and remove the assembly.
- Fit new assembly and screw in place.
- Reassemble and test for correct operation.

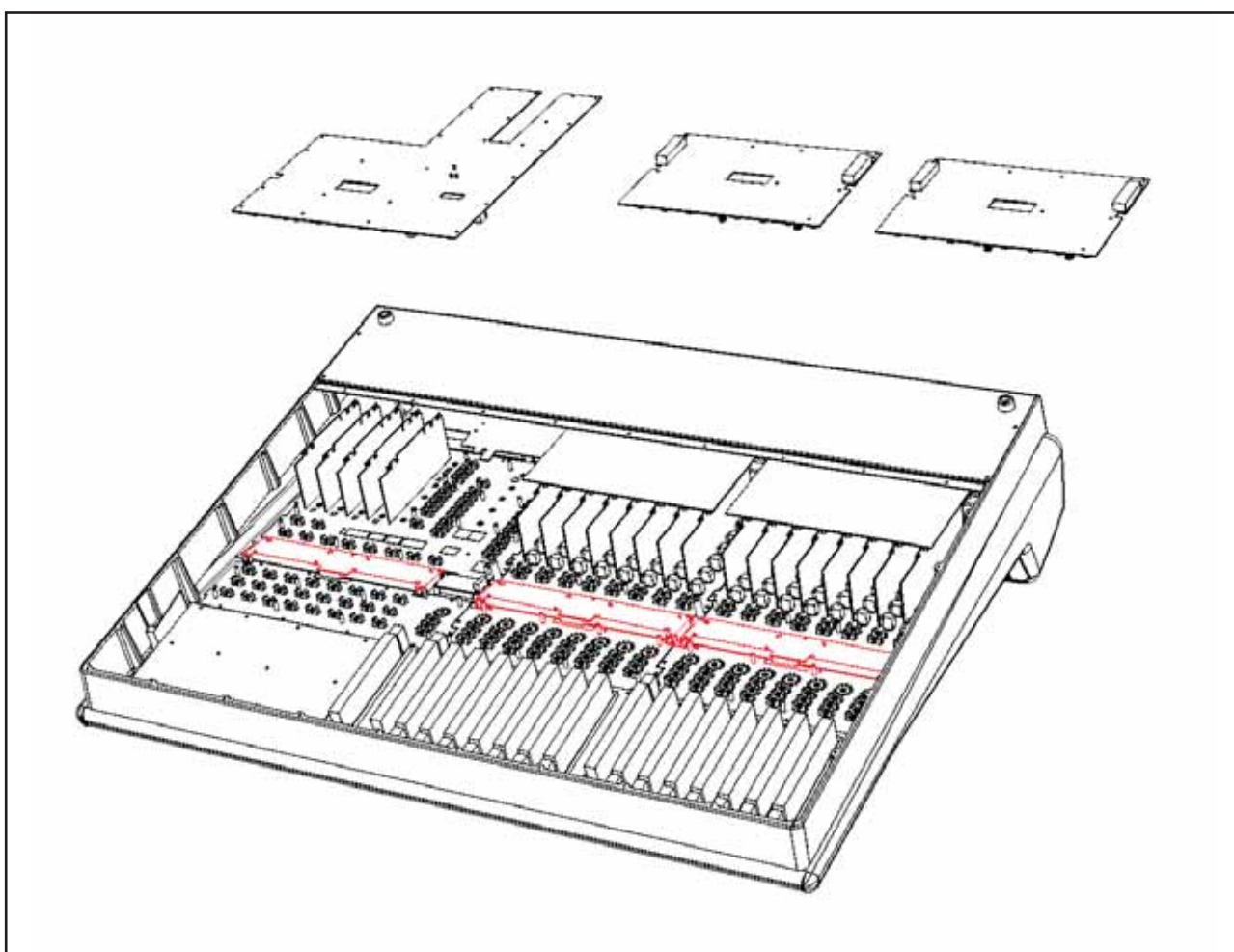

8 - 41HJYLC2 Small Centre Section Replacement

- Follow instruction #5 for 629506XA removal to reveal the display.
- Remove the two pan Pozi screws.
- Fit new assembly and screw in place.
- Reassemble and test for correct operation.

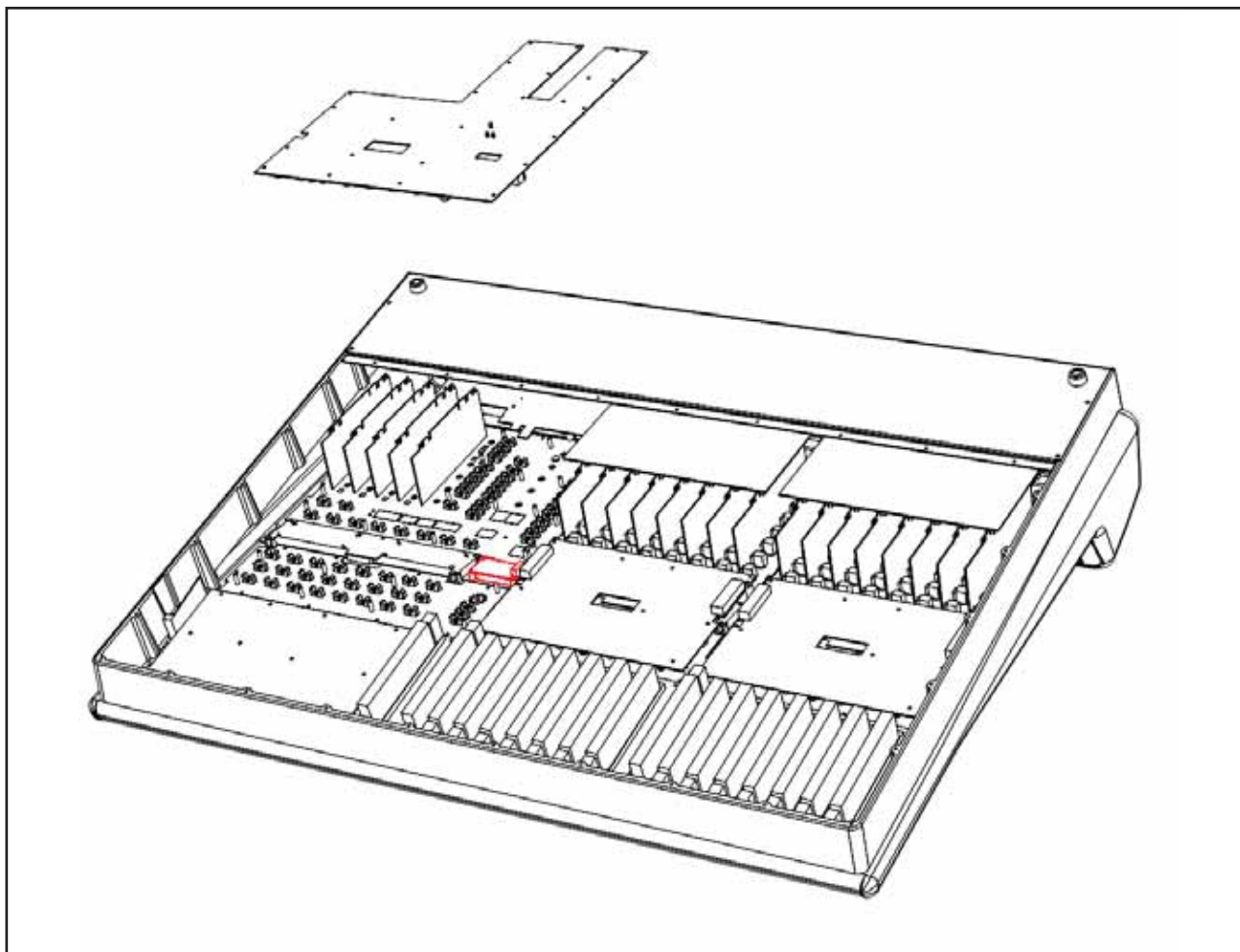

9 - 629507XC Motion Control

- Using a 2mm Hex driver loosen the grub screw in the jog wheel and then remove. Take care not to lose the plastic washer underneath the jog wheel.

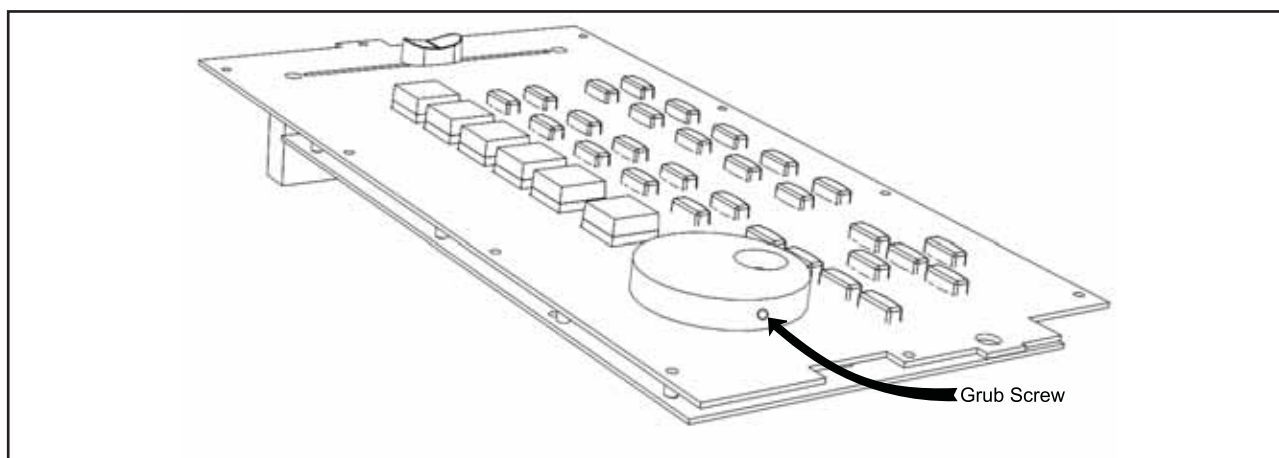

- Follow instruction #1 for the removal of the base plate.
- Disconnect Loom J and the two master fader connections from the motion control assembly.
- Remove the 12 screws securing the motion control assembly to the front plate.
- Replace with new assembly and reassemble, take care when refitting the jog wheel to ensure free rotation.

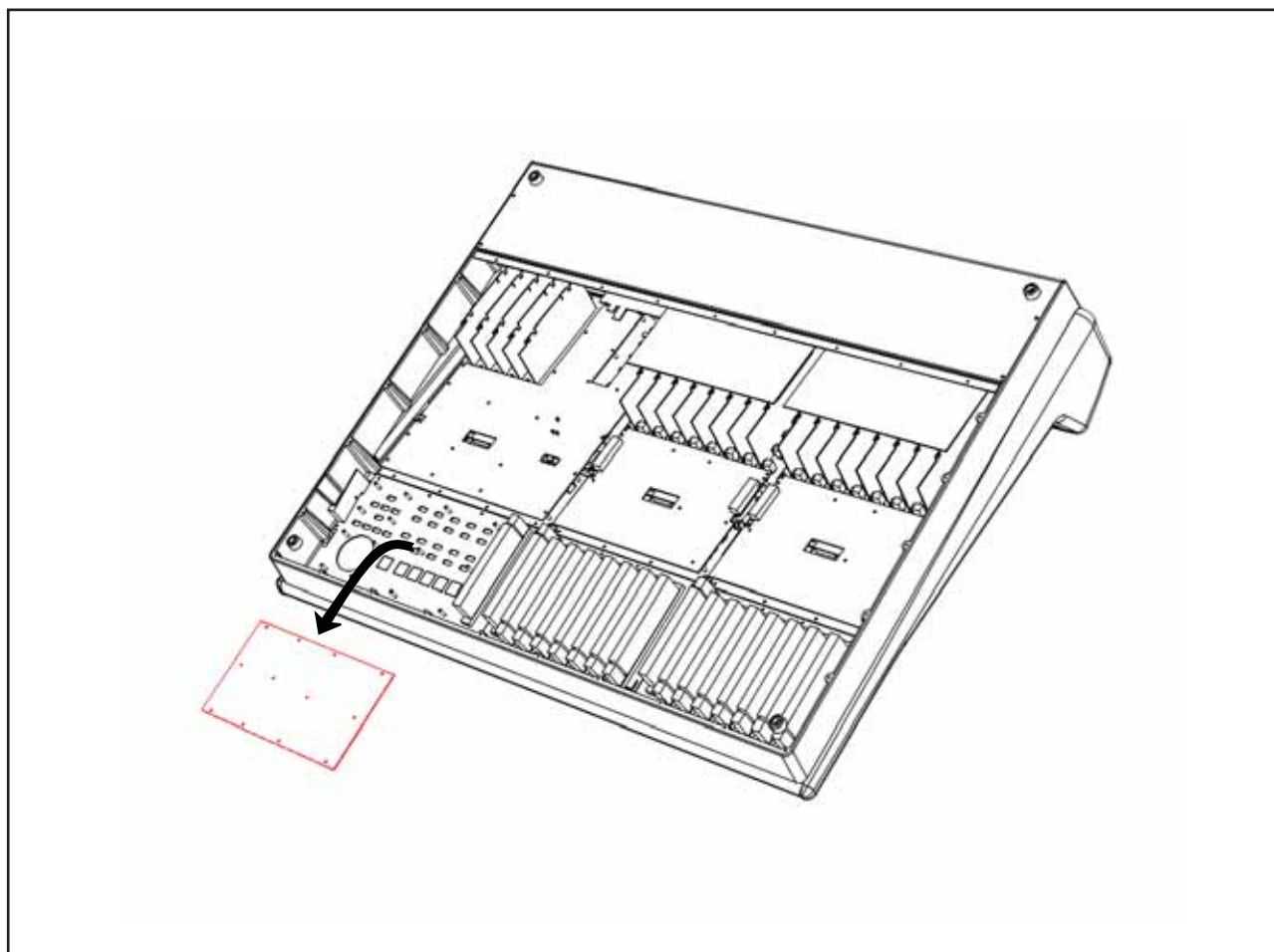

10 - 629507XD Headphone/iJack Panel Replacement

- Follow instruction #9 for the removal of the 629507XA motion control panel.
- Remove the ten screws securing the mounting plate to the frame.
- Remove the mounting plate, unplugging loom AB from the headphone assembly as you raise the panel.
- Remove the screw securing the headphone PCB to the mounting plate.
- Remove the nut from the headphone jack socket.
- Fit the replacement assembly and reassemble the console.

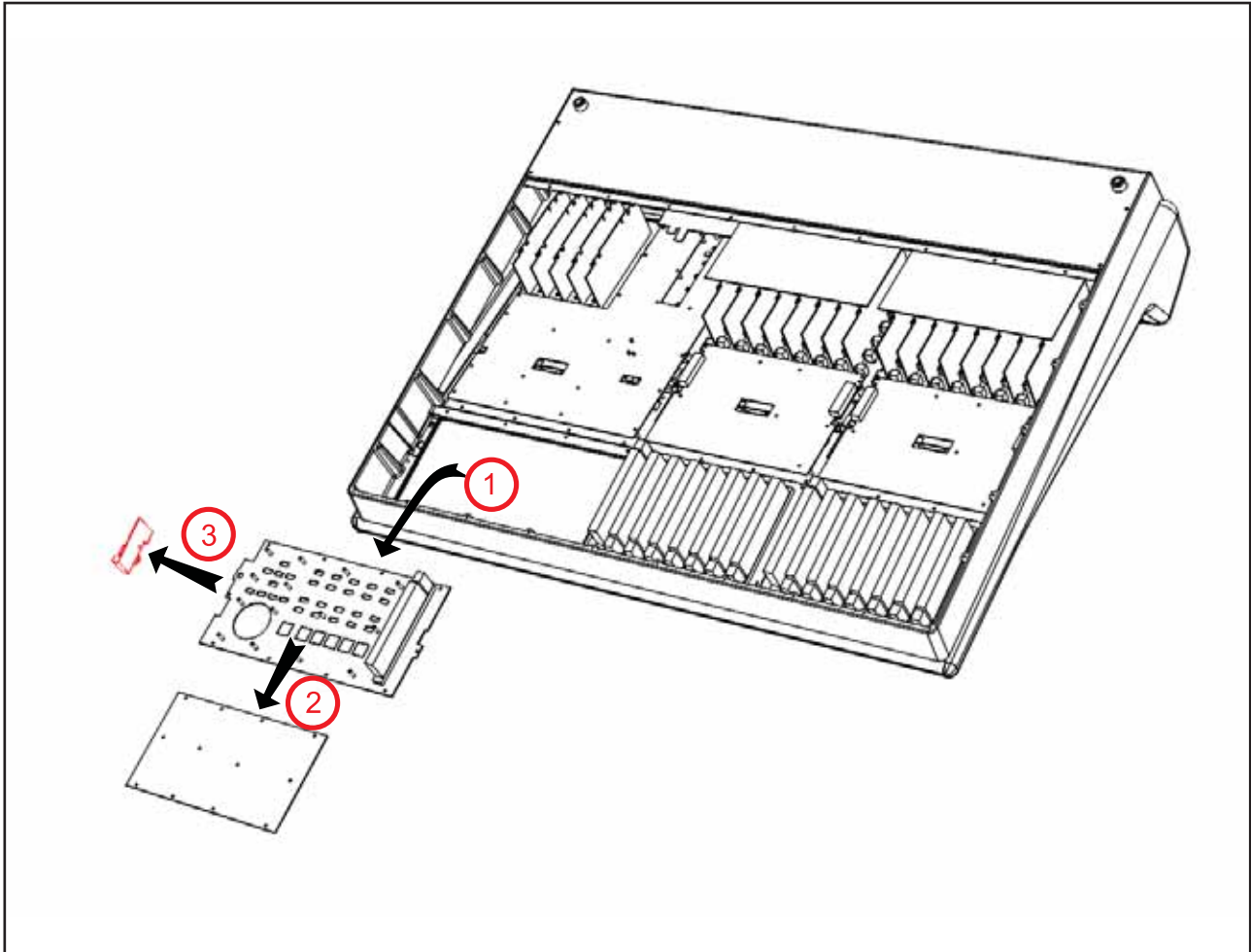

11 - 629510X1 Channel Buscard Replacement

- Follow instruction #1 for base plate removal.
- Unscrew the rear connector panel and slide the rear panel away from the console slightly to gain access to buscards.
- Unplug the two looms crossing over the top of the channel buscard and the loom connecting to the solo and cuts panel.
- The buscard is locked to the channel modules with four (six on later units) plastic retaining strips, clipping the card at each corner.
- To remove the card, press the tabs on two adjacent clips and pull the card upwards slightly so that the clips do not lock back in place, repeat for the remaining two clips.
- Lift the buscard clear and unplug the remaining looms.
- Early Matrix consoles were shipped with a terminating header inserted in socket PL2A of channel 1-8's buscard. If fitted remove and fit to the replacement card.
- When fitting the replacement buscard ensure that all four locking clips are in place and that all cards fully inserted.
- Reconnect all cables.

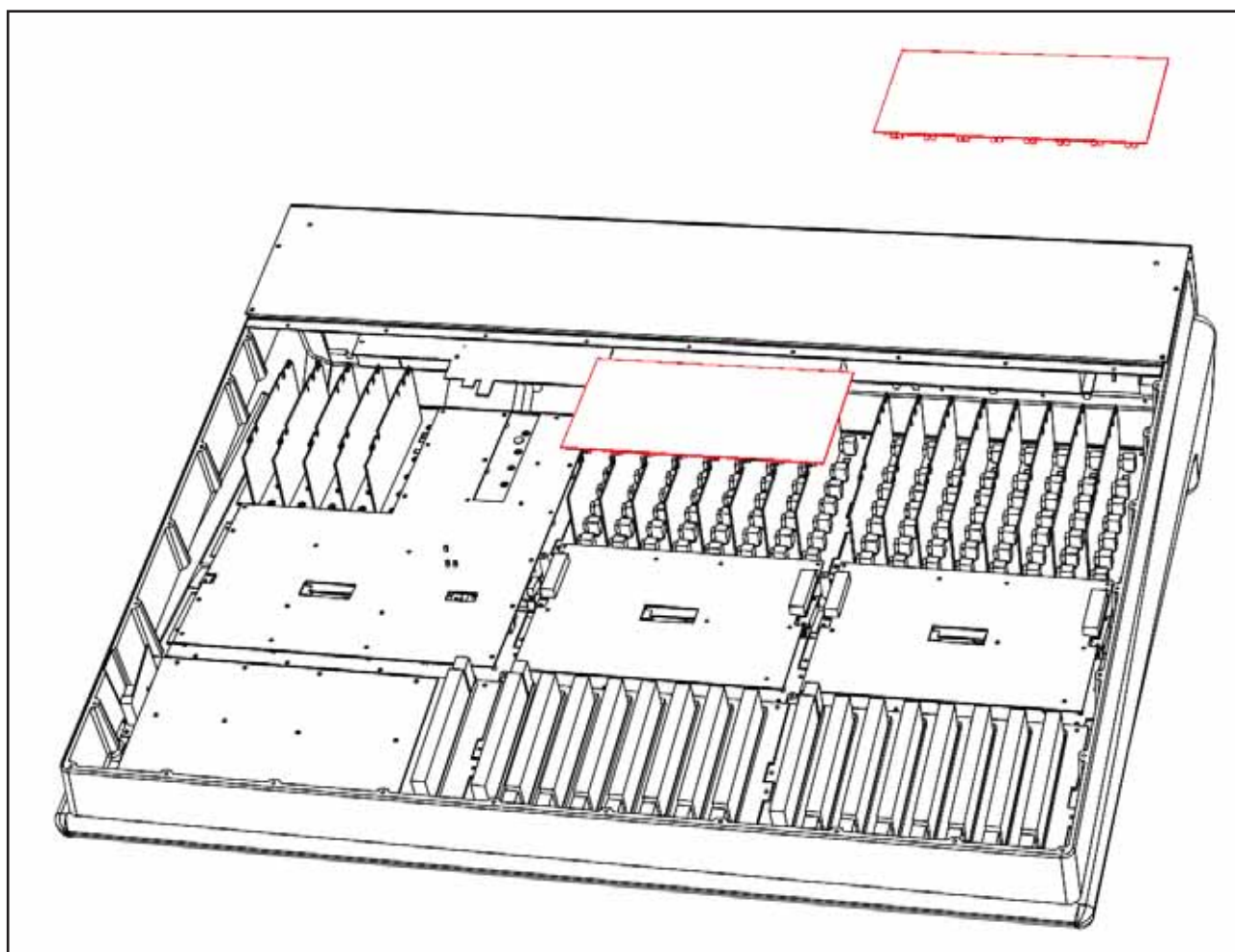

12 - 629501X2 Channel Module Replacement

- Remove the knob caps and retaining collars from the channel module to be replaced.
- Follow instructions #1 and #2 for the removal of the base plate and rear panel.
- Follow the instruction #11 for the removal of 629510X1 channel buscard.
- The faulty module will be attached to the buscard, fit the replacement assembly to the buscard and reassemble.

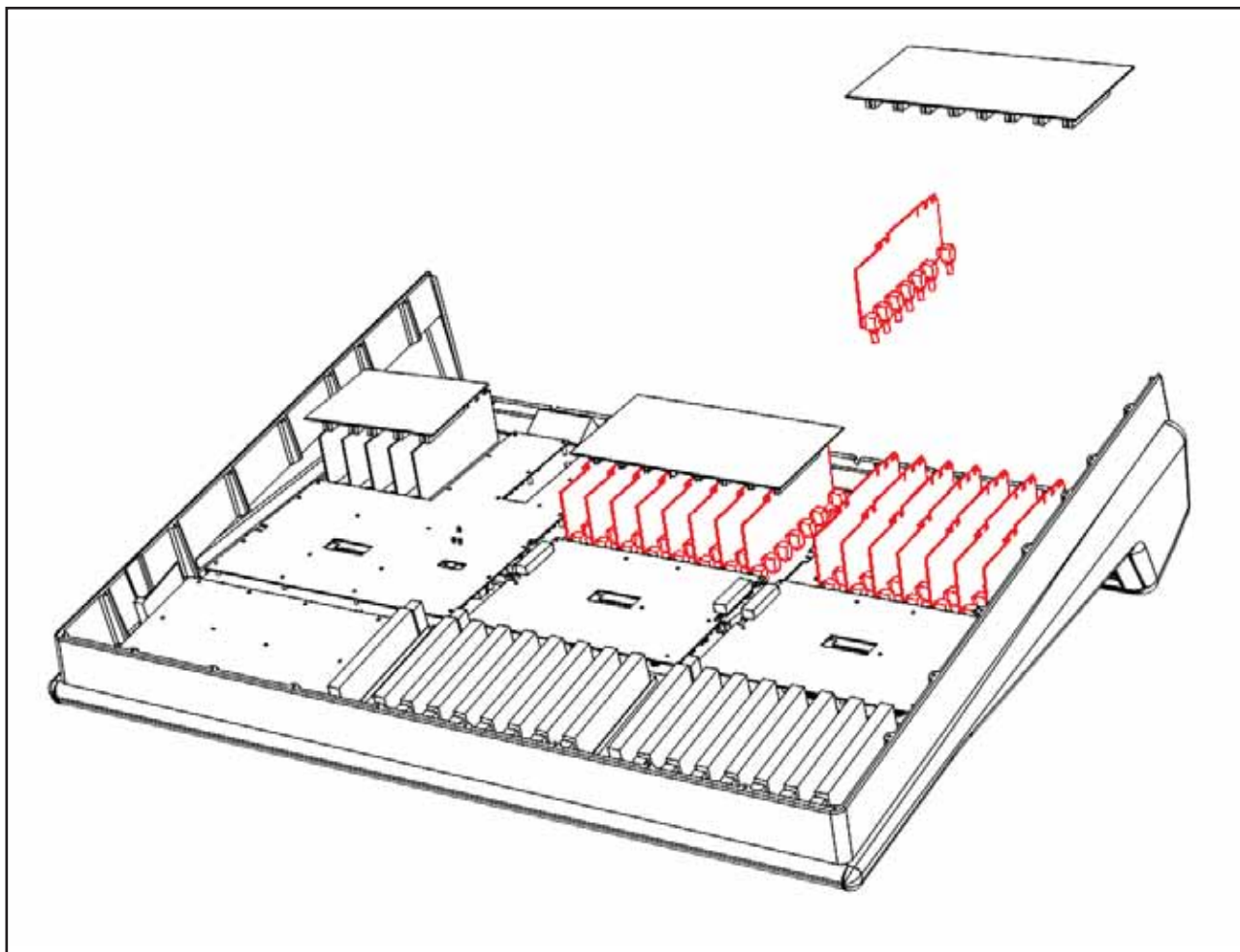

13 - 629511X1 Centre Section Buscard Removal

- Follow instruction #1 for removal of the base plate, unscrew and slide the rear panel backwards to gain access to buscards.
- Unplug loom G from the channel buscard to allow easy access to the centre section buscard.
- The buscard is locked to the centre section modules with four plastic retaining clips, one at each corner.
- To remove the card, press the tabs on two adjacent clips and pull the card upwards slightly so that the clips do not lock back in place, repeat for the remaining two clips. Lift the buscard clear and unplug the remaining looms.
- When fitting the replacement buscard ensure that all four locking clips are in place and that all cards fully inserted.

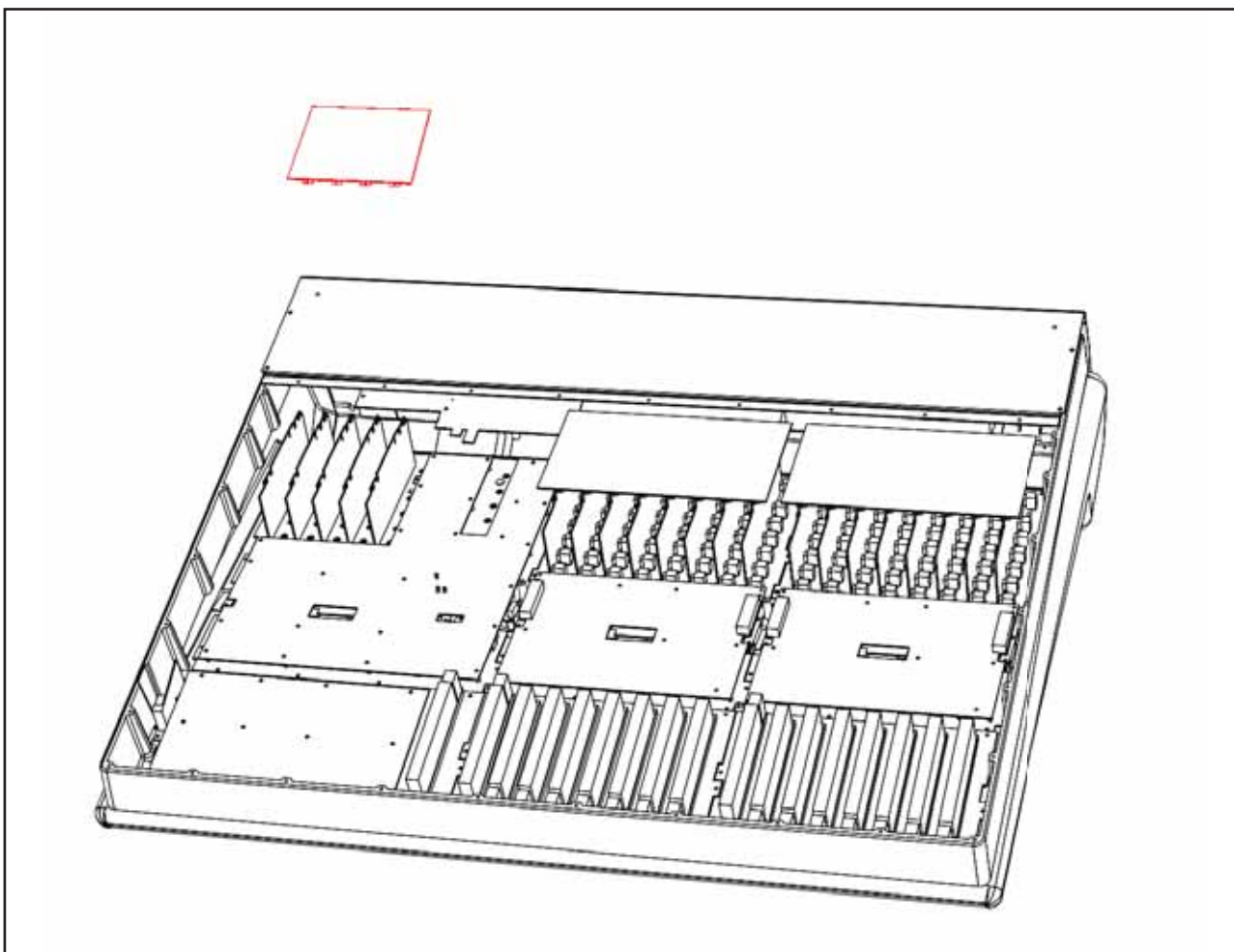

14 - Centre Section Module Replacement

- Remove the knob caps and retaining collar from the channel module to be replaced.
- Follow instruction #1 for the removal of the base plate, unscrew and slide the rear panel backwards to gain access to buscards.
- Follow the instruction for the removal of 629511X1 centre buscard.
- The faulty module will be attached to the buscard, fit the replacement assembly to the buscard and reassemble.

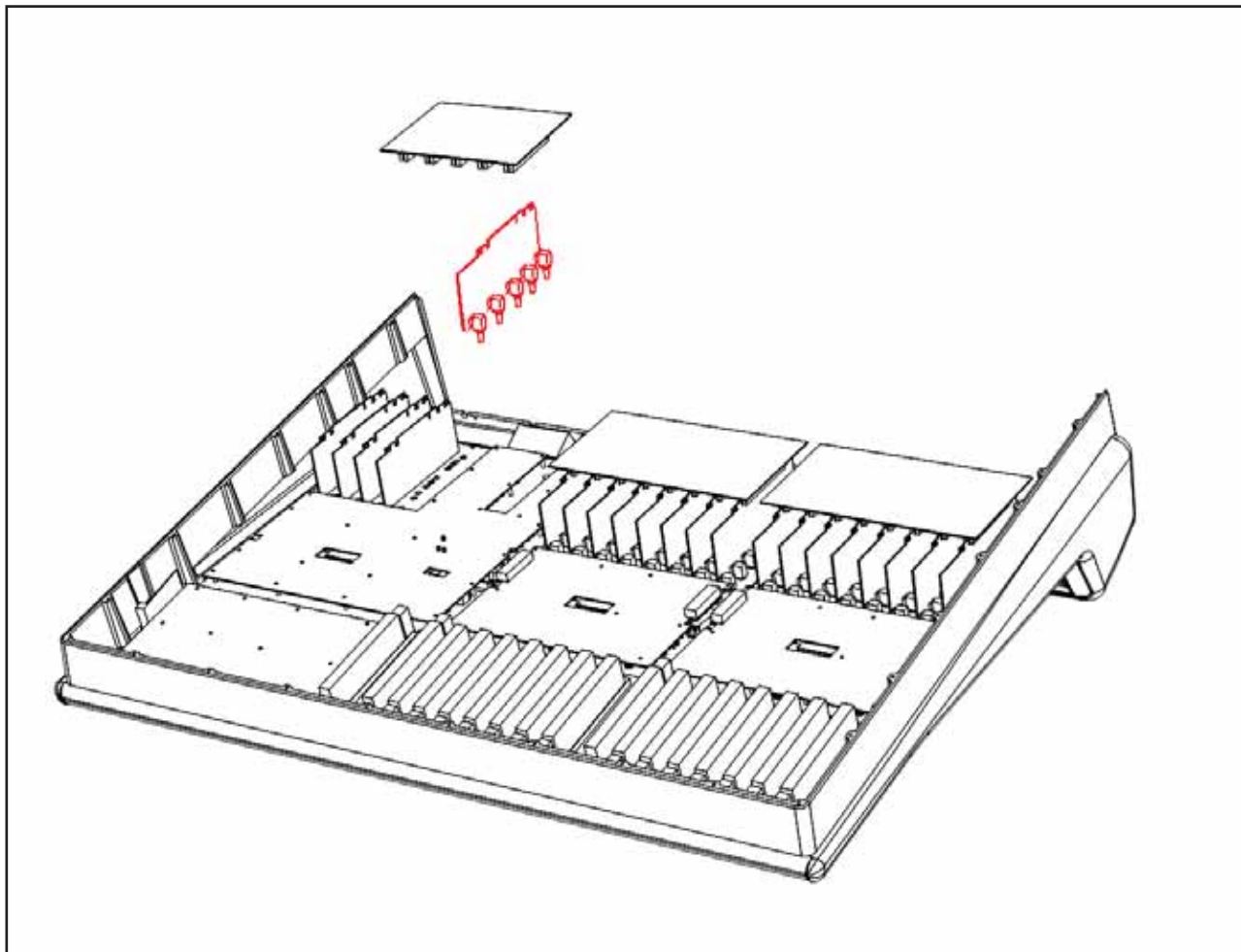

15 - 629516X1 Router Replacement

- Follow instruction #2 for removal of the rear connector panel.
- Remove the connecting looms.
- Using a #1 Pozi-drive screwdriver, remove two fixing screws.
- Remove the retaining nuts from each of the boards D type connectors using a 5.5mm nut spinner.
- Lift the assembly clear.

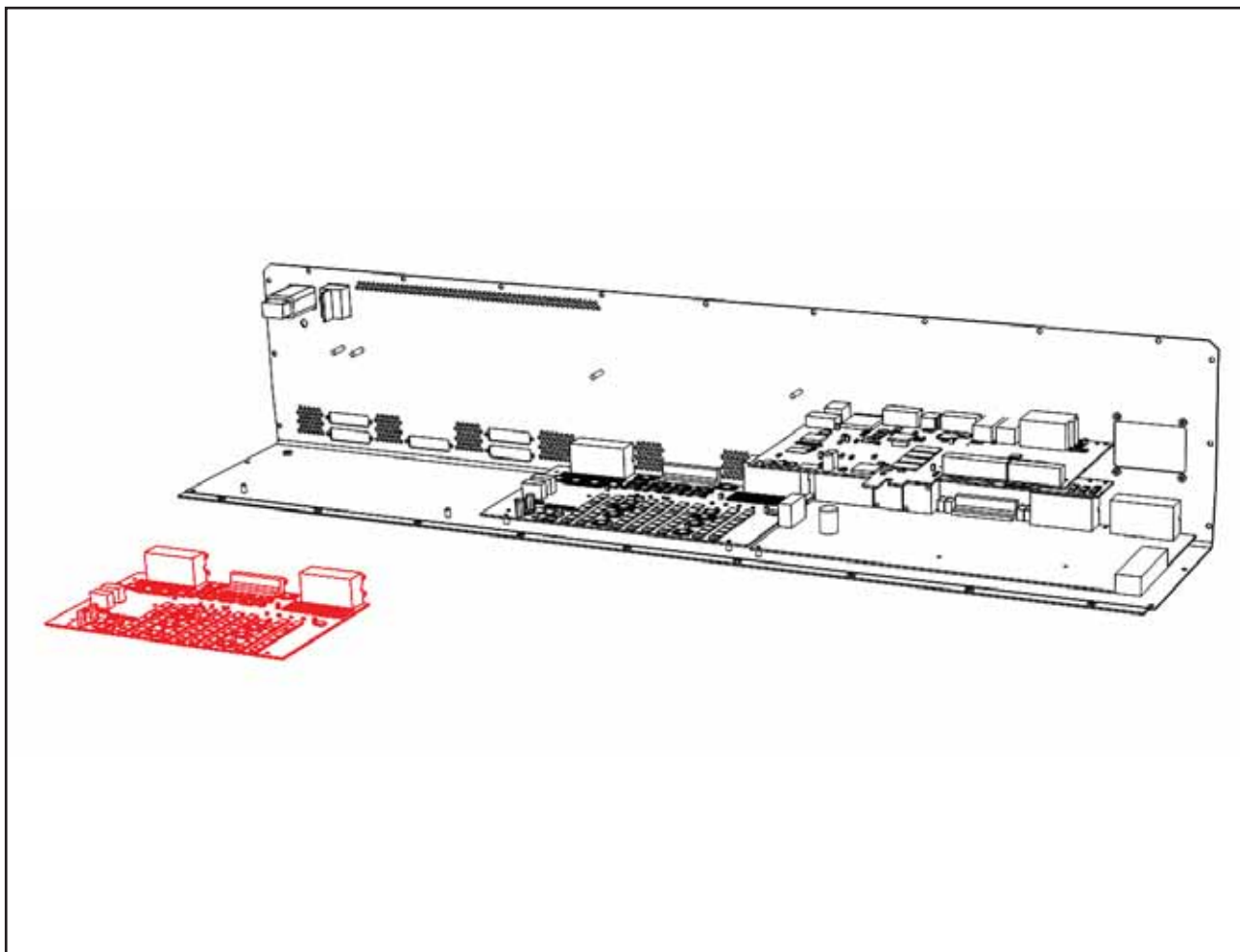

16 - 629505XA CPU Replacement

- Remove the SD memory card from the console.
- Follow instruction #2 for removal of the rear connector panel.
- Remove the 9-way D-type retaining nuts from the GPIO and XRACK/DIAG connectors on the rear panel.
- Remove all looms connected to the 629505XA assembly.
- Remove four pan Pozi screws.
- Lift the assembly clear of the console.
- Fit the replacement card and reassemble.
- Refit the SD memory card.

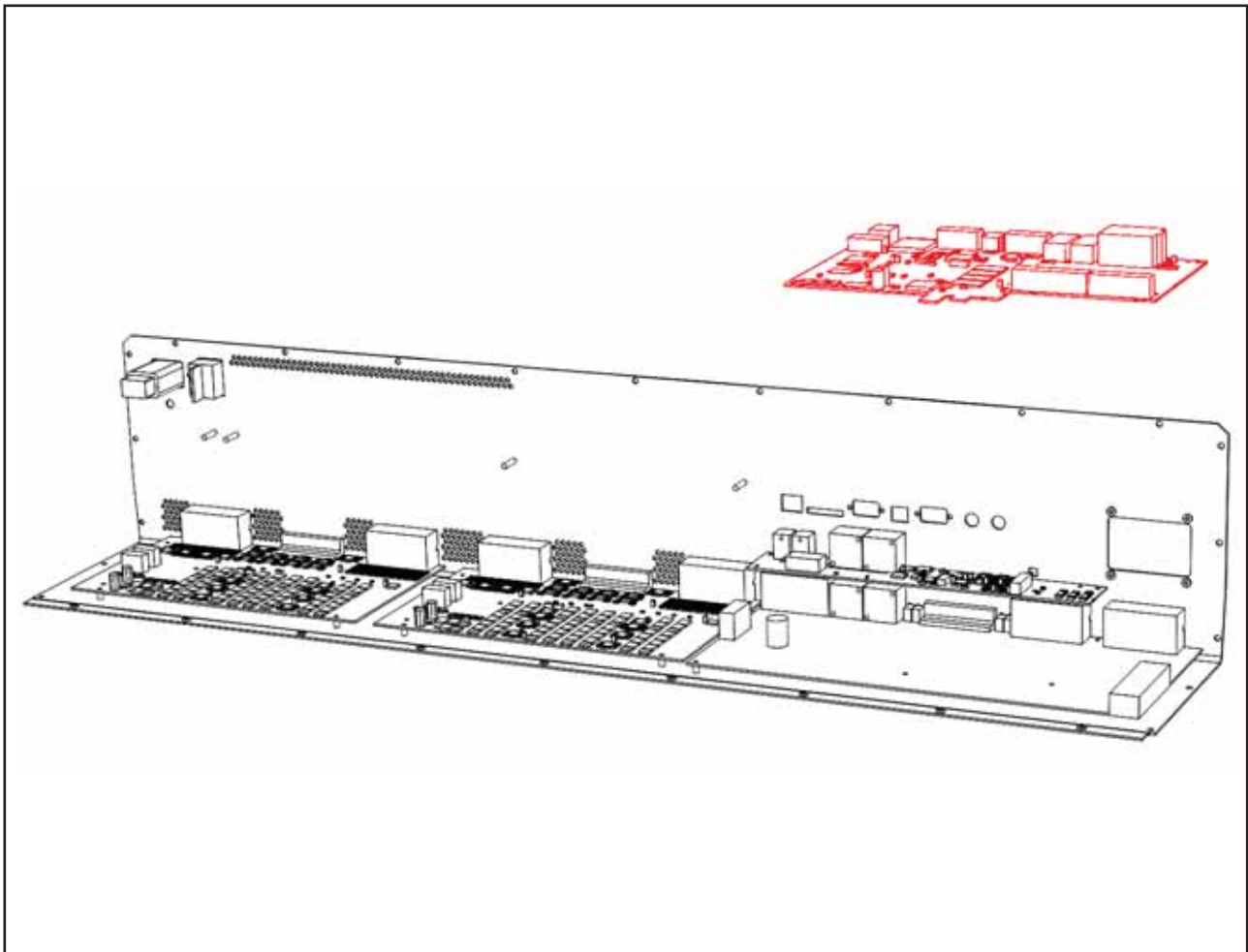

17 - 629505XB Digital Interface Replacement

- Follow instruction #2 for removal of the rear connector panel.
- Remove the pan Pozi screws holding the 629505XB assembly in to the 629505XA CPU.
- Disconnect loom P.
- Remove the screws from the AES and S/PDIF connectors on the rear panel.
- Remove the faulty assembly and transfer the plastic pillar to the replacement part.
- Fit the new assembly and reassemble.

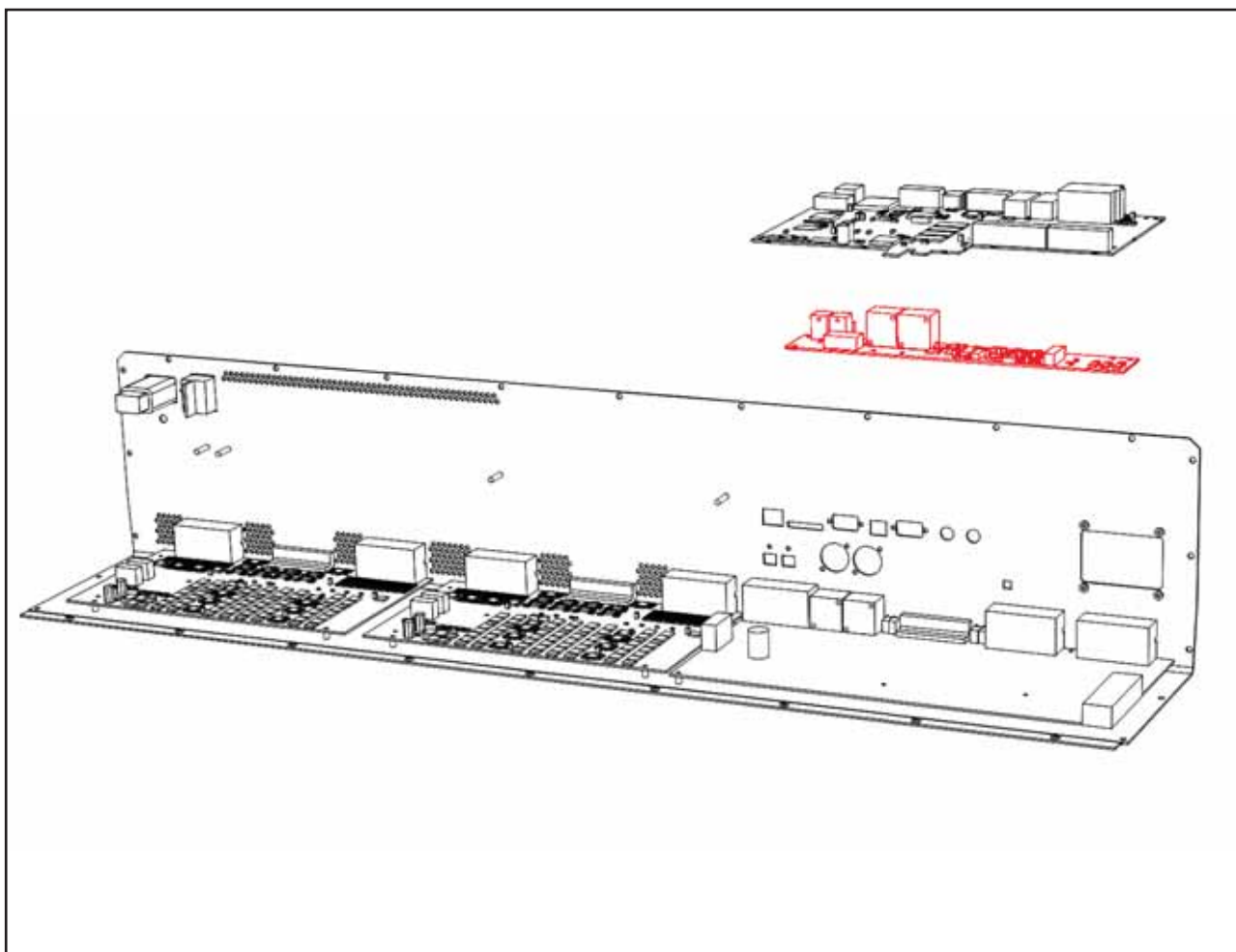

18 - 629515X1 Centre Section Rear Replacement

- Follow instruction #2 for removal of the rear connector panel.
- Remove the 9-way D-type retaining nuts from the GPIO and XRACK/DIAG connectors on the rear panel.
- Remove all looms connected to the 629505XA assembly.
- Remove four pan Pozi screws holding the 629505XA assembly in place and remove the assembly from the console.
- Remove the remaining D-Type retaining nuts from rear of console's centre section.
- Unplug all looms connecting to the 629515X1 assembly.
- Unscrew the three plastic pillars.
- Replace the 629515X1 assembly and reassemble.

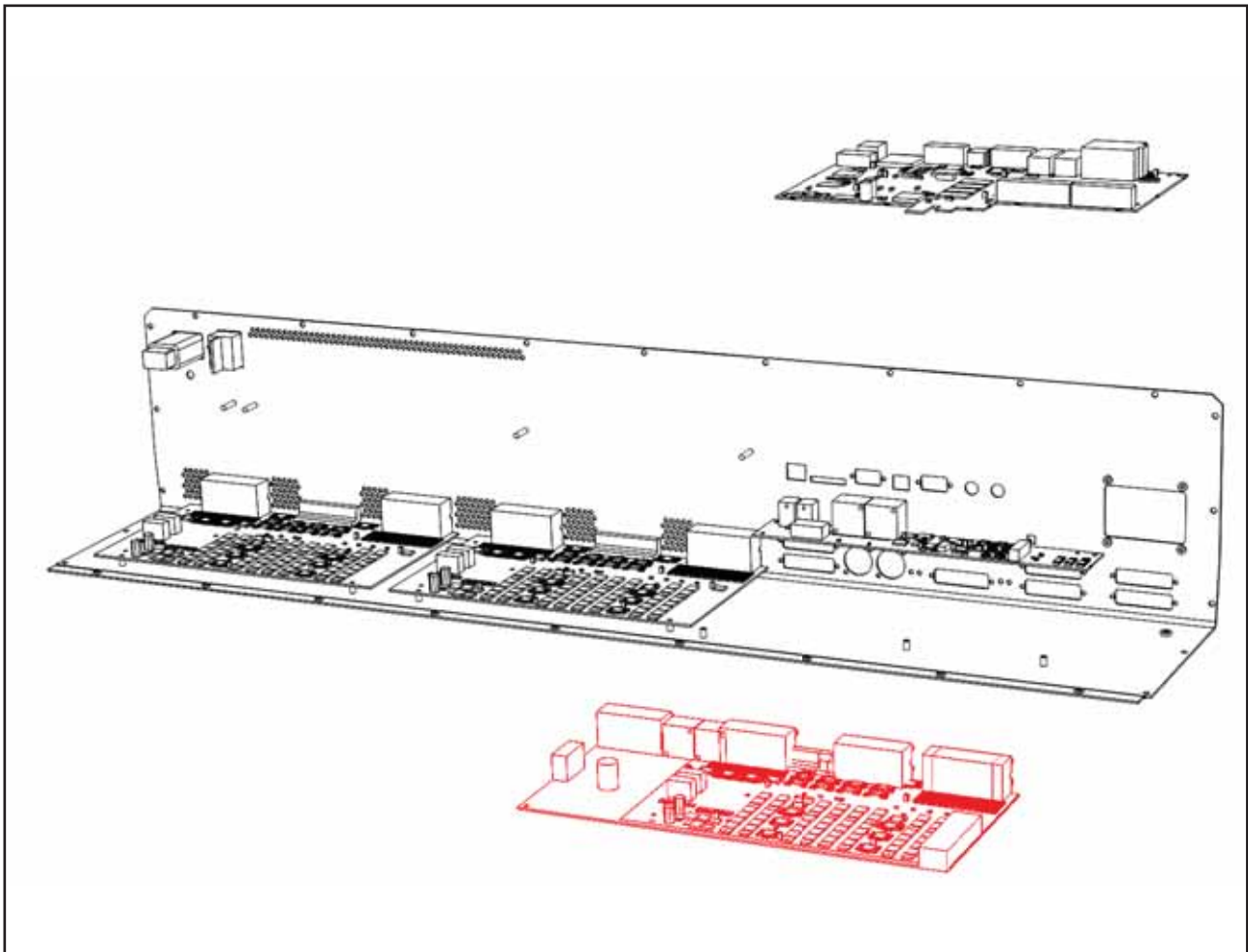

19 - 629503X1 Channel Display Replacement

- Follow instruction #2 for removal of the rear connector panel.
- Remove the connecting looms from the meter assembly.
- Note that the 629503X1 assembly uses a picoflex connector. To remove this connector grip the connector body firmly and pull directly away from the assembly, pulling the connector at an angle may damage the plastic locating pins.
- Remove the 10 nuts holding the assembly in place using a 5.5mm spanner or nut spinner.
- Fit the replacement assembly and reassemble.

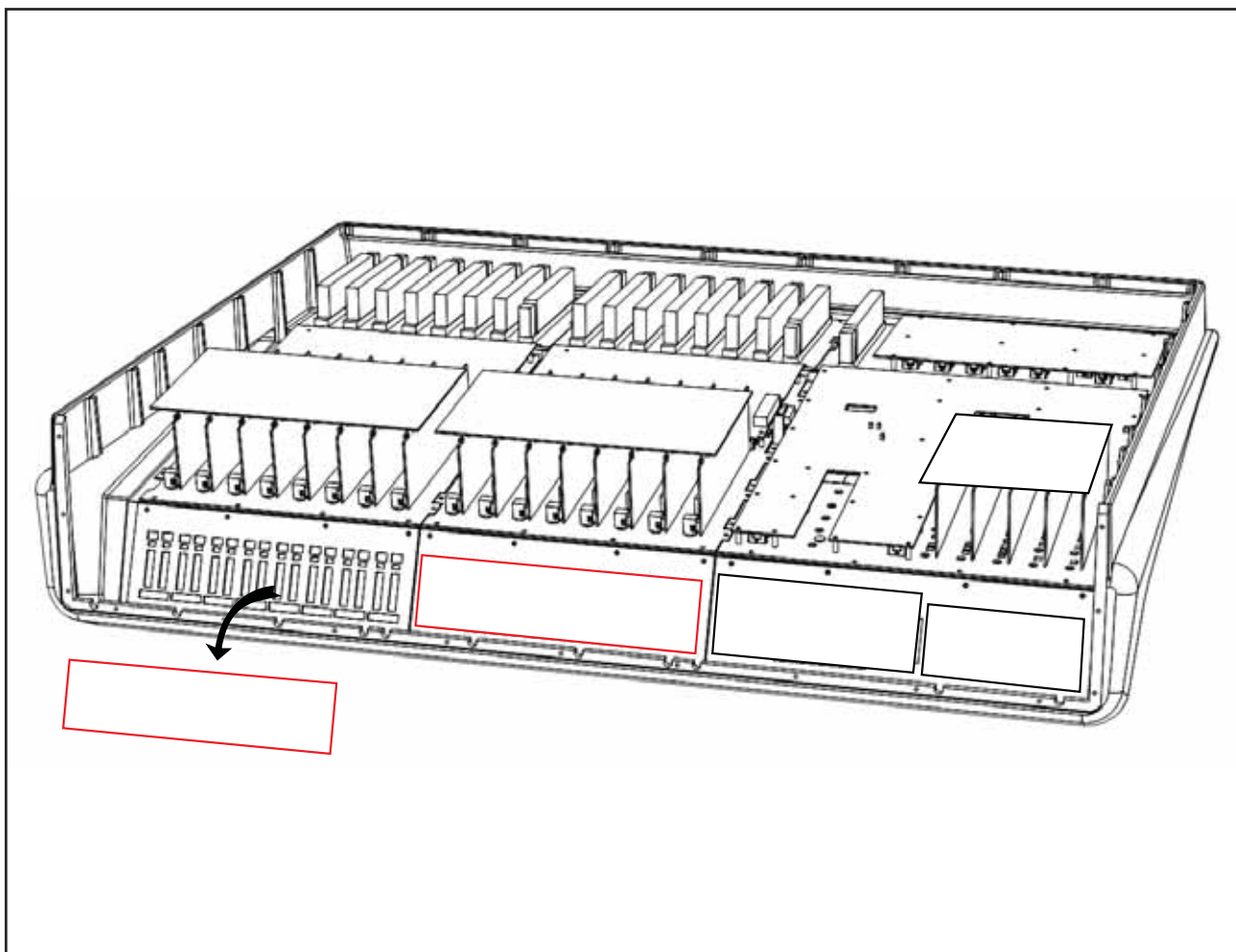

20 - 629512X1 C/S LCD Meters Replacement

- Follow instruction #2 for removal of the rear connector panel.
- Remove looms AA and Q from the meter assembly.
- Note that looms AA and Q use a Picoflex connector. To remove this connector grip the connector body firmly and pull directly away from the assembly, pulling the connector at an angle may damage the plastic locating pins.
- Remove the four nuts holding the assembly in place using a 5.5mm spanner or nut spinner.
- Fit the replacement assembly and reassemble.

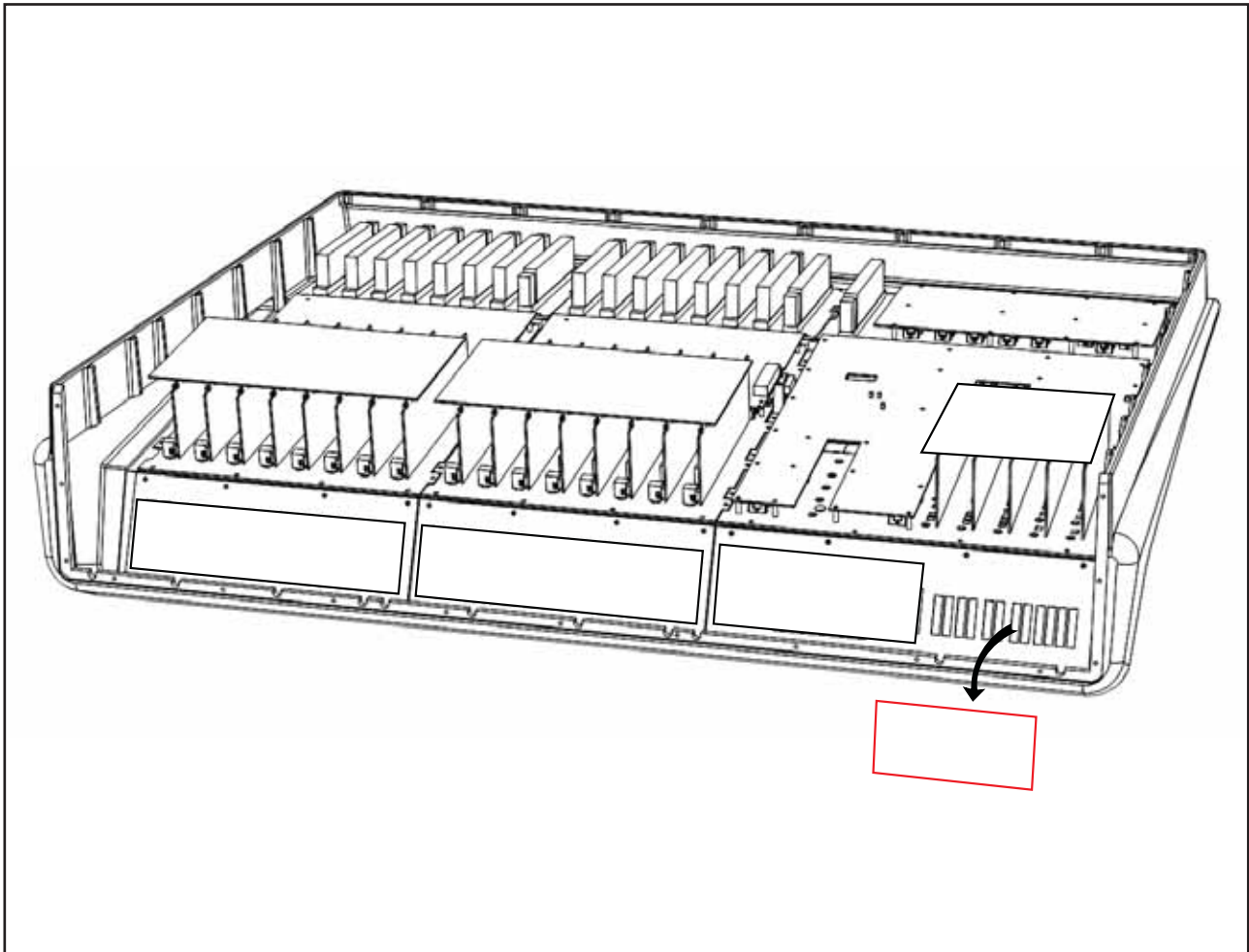

21 - VU Meter Replacement

- Follow instruction #2 for removal of the rear connector panel.
- Remove the spade connectors from the rear of the VU meters - making note of which is the positive terminal.
- Remove the three fixing screws and lift the VU PCB clear.
- Using a 6BA nut spinner or spanner remove the two brass fixing nuts from the rear of the VU meter to be replaced.
- Fit the replacement part and reassemble.
- Follow the calibration procedure on the next page.

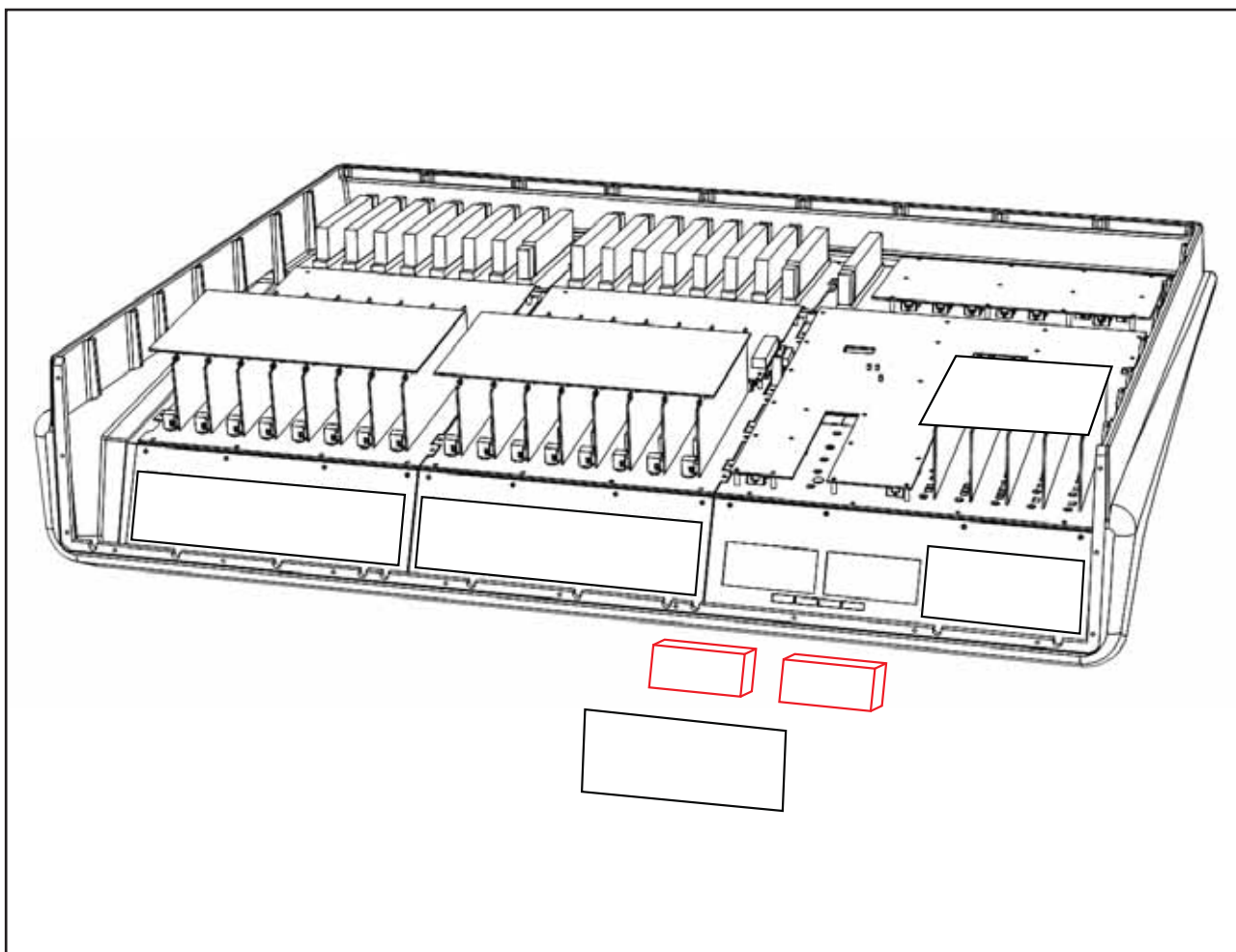

22 - 5.1 Surround Card Removal

- Follow instruction #2 for removal of the rear connector panel.
- Locate the surround card at the left end of the rear panel.
- Remove the single ribbon connector from the surround card as indicated below.
- Remove the four M3 retaining screws from the rear panel as shown in the lower diagram.
- Withdraw the card through the aperture in the rear panel, taking care not to catch the ribbon cable on the frame edges.

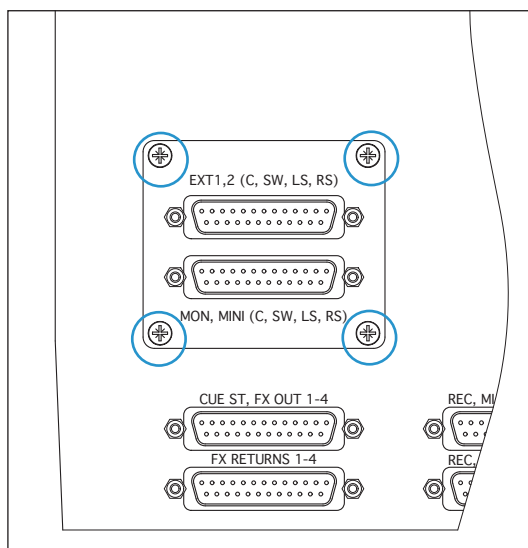
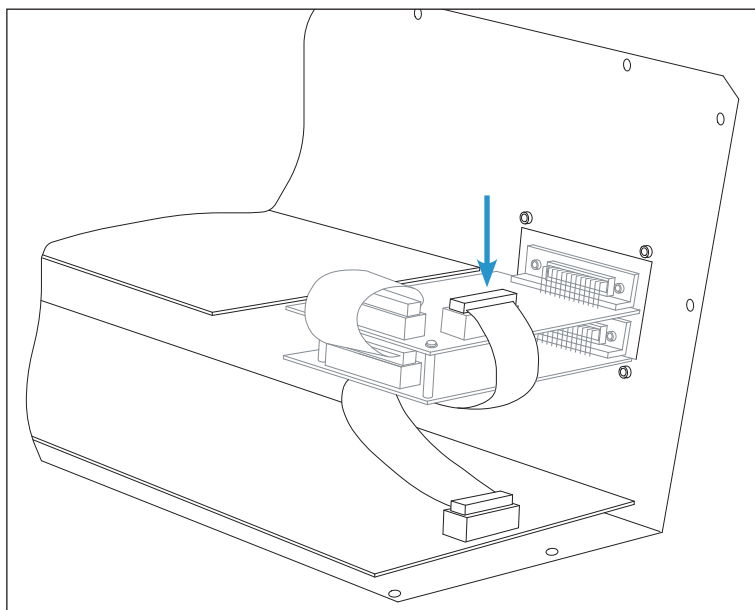

VU Meter calibration

- Route a calibrated 0 VU source to the left Mix insert return. Alternatively, connect a level meter to the console's Mix bus output, route a tone to the Mix bus and set the master fader to give a reading of 0 VU on the output.
- Deselect the Mix insert sum function.
- Deselect the VU meter -10dB function.
- Locate the VU meter trim pot at the rear of the console. Using a trim tool, or small flat blade screwdriver, adjust the trim pot to align the left VU meter needle with the 0 VU legend.
- Repeat for the procedure for the right meter.

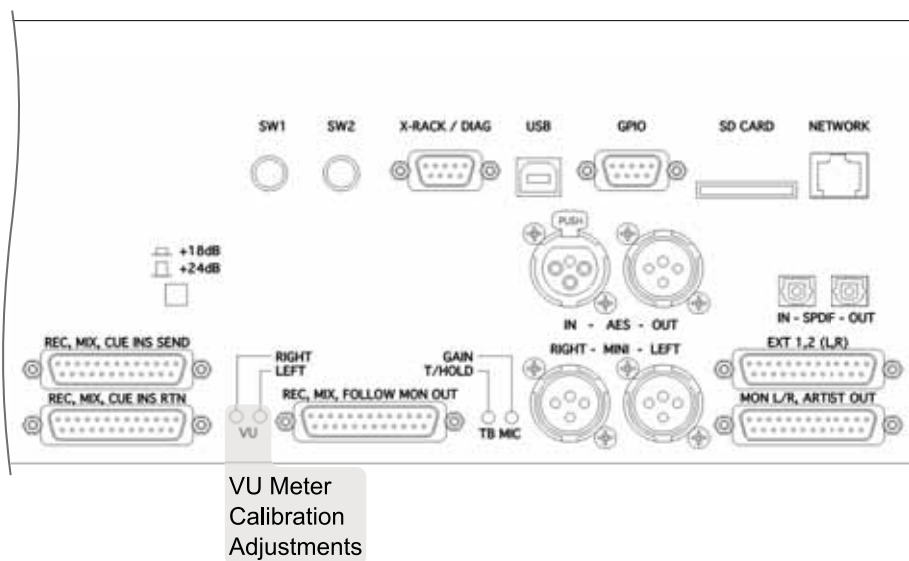

Signal Flow Drawings

The following two pages of the Matrix Hardware Signal Flow Block Diagram depict how the various sub assemblies within Matrix interconnect and which audio functions they perform.

Different coloured blocks are used to distinguish the assemblies. The number shown in the top left hand corner of each block is the partcode of the assembly.

All function shown outside of a coloured block are performed by the 629515X1 assembly.

The channel and centre section buscards which provide the consoles bus structure have been omitted for clarity.

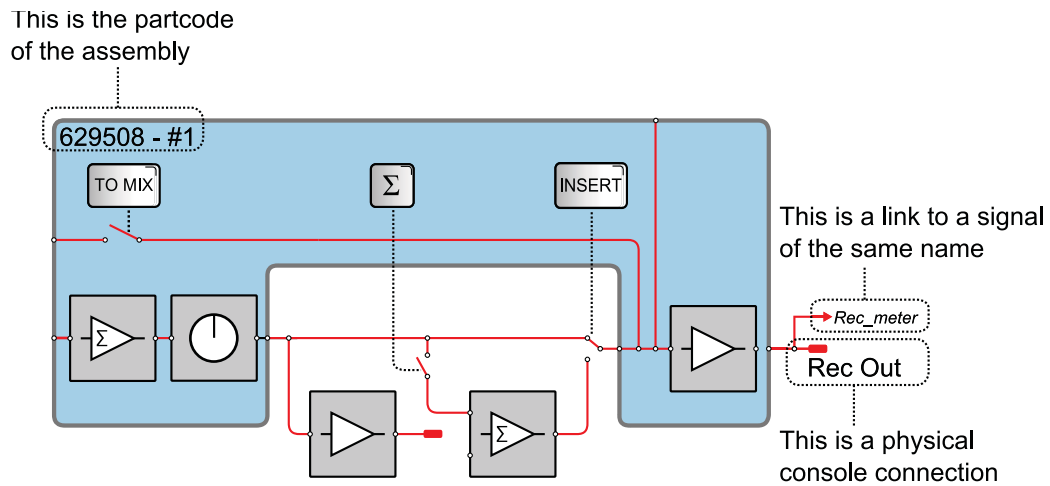

Matrix Internal Wiring Diagram

The following diagram depicts all of the console's internal wiring connections. Each connection on the drawing is marked with a connector name shown within italic braces, {}, which is the name found printed on the assembly's PCB, adjacent to the connector and a loom reference which is physically labeled on each cable within the console.

The exception to this are the ribbon cables on the LCD displays, these cables do not have a loom reference.

This page is intentionally almost blank



Solid State Logic

International HQ: Begbroke, Oxford, England OX5 1RU · Tel +44 (0)1865 842300 · Email sales@solidstatelogic.com

France: 7 bis, rue de la Victoire, 93150 Le Blanc Mesnil, France · Tel +33 (0)1 48 67 84 85 · Email frsales@solidstatelogic.com

Italy: Via Timavo 34, 20124 Milano, Italy · Tel +39 0392 328094 · Email itales@solidstatelogic.com

New York: 320 West 46th Street, New York, NY 10036 · Tel +1 212 315 1111 · Email nysales@solidstatelogic.com

Los Angeles: 3700 Wilshire Boulevard, Suite 720, Los Angeles, CA 90036 · Tel +1 213 249 9229 · Email lasales@solidstatelogic.com

Japan: 3-55-14 Sendagaya, Shibuya-Ku, Tokyo 151-0051 · Tel +81 (0)3 5474 1144 · Email jpsales@solidstatelogic.com

© 2012 by Solid State Logic. All Rights reserved under International and Pan-American Copyright Conventions. Solid State Logic and SSL are trademarks of Solid State Logic. All other trademarks are the property of their respective owners. No part of this publication may be reproduced in any form or by any means, whether mechanical or electronic, without the written permission of Solid State Logic, Oxford, England. Solid State Logic has a policy of continual product enhancement and reserves the right to alter specifications without notice. E&OE. 20.07.12.